

Pressure transmitter for general applications

Model S-10, standard version

Model S-11, flush diaphragm

WIKA Data Sheet PE 81.01

Applications

- Mechanical engineering
- Hydraulics / Pneumatics
- General industrial applications
- Food industries

Special Features

- Pressure ranges from 0 ... 0.1bar to 0 ... 1000 bar
- Various industrial standard signal outputs
- Wiring with connector or flying leads
- Stock programm for short delivery times
- Vacuum tight



Fig. left Pressure transmitter S-10

Fig. center Pressure transmitter S-11

Fig. right Pressure transmitter S-11 with cooling element

Description

This series of pressure transmitters has been carefully designed to cover the majority of industrial applications with instruments readily available from stock.

Compact design and robust construction make these instruments suitable for all applications in machine construction, process control, laboratory or quality and materials testing equipment.

There is an extraordinary range of instrument variants resulting from the fact that various mechanical and electrical connections can be combined with each other to almost any extent.

Structure

All wetted parts are made of stainless steel and are hermetically welded. Therefore there is no need for additional sealing material, which could possibly react with the pressure medium. The compact case is also made of stainless steel and provides IP 65 ingress protection (special versions up to IP 68).

The transmitters can be supplied with a non-stabilized direct voltage of 10 (14) ... 30 V and provide standard industrial output signals.

The model S-11 with flush diaphragm is particularly suitable for the measurement of viscous fluids or media containing particulates that may clog the pressure connection of standard industrial transmitters. Thus, a trouble-free pressure measurement is ensured. Pressure transmitters with flush diaphragm are available in pressure ranges from 0 ... 0.1bar to 0 ... 600 bar. For applications with higher temperature requirements an integrated cooling element enables medium temperatures of up to 150 °C (302 °F).

For the pressure ranges from 0 ... 0.25 bar up to 0 ... 1000 bar the pressure transmitters can be delivered for oxygen applications (technical safety check of the BAM, Bundesanstalt für Materialforschung und -prüfung available).

Specifications

Model S-10 / S-11

Pressure ranges	bar	0.1	0.16	0.25	0.4	0.6	1	1.6	2.5	4	6	10
Over pressure safety	bar	1	1.5	2	2	4	5	10	10	17	35	35
Burst pressure	bar	2	2	2.4	2.4	4.8	6	12	12	20.5	42	42
Pressure ranges	bar	16	25	40	60	100	160	250	400	600	1000 ¹⁾	
Over pressure safety	bar	80	50	80	120	200	320	500	800	1200	1500	
Burst pressure	bar	96	96	400	550	800	1000	1200	1700 ²⁾	2400 ²⁾	3000	
{Vacuum, gauge pressure, compound range, absolute pressure are available}												
¹⁾ Only Model S-10.												
²⁾ For model S-11: the value specified in the table applies only when sealing is realised with the sealing ring underneath the hex. Otherwise max. 1500 bar applies.												
Materials		(other materials see WIKA diaphragm seal program)										
■ Wetted parts		Stainless steel										
> Model S-10		Stainless steel {Hastelloy C4}										
> Model S-11		O-ring: NBR ³⁾ {Viton or EPDM}										
■ Case		Stainless steel										
Internal transmission fluid ⁴⁾		Synthetic oil {Halocarbon oil for oxygen applications} ⁵⁾										
		{Listed by FDA for food industry}										
		³⁾ O-ring made of Viton or EPDM for Model S-11 with integrated cooling element.										
		⁴⁾ Not for S-10 with pressure ranges > 25 bar										
		⁵⁾ Media temperature for oxygen version: -30 ... +60 °C / -22 ... 140 °F (S-11 up to max. 40 bar).										
		Cannot be manufactured for vacuum and absolute pressure ranges.										
Power supply U _B	U _B in DC V	10 < U _B ≤ 30 (14 ... 30 with signal output 0 ... 10 V)										
Signal output and maximum load R _A	R _A in Ohm	4 ... 20 mA, 2-wire R _A ≤ (U _B - 10 V) / 0.02 A										
		0 ... 20 mA, 3-wire R _A ≤ (U _B - 3 V) / 0.02 A										
		{0 ... 5 V, 3-wire} R _A > 5,000										
		{0 ... 10 V, 3-wire} R _A > 10,000 {other signal outputs on request}										
Adjustability zero/span	%	± 10 via potentiometers in the instrument										
Response time (10 ... 90 %)	ms	≤ 1 (≤ 10 ms at medium temperatures below -30 °C for pressure ranges up to 25 bar or with flush diaphragm)										
Test of voltage strength	DC V	500										
		⁶⁾ NEC Class 02 power supply (low voltage and low current max. 100 VA even in fault conditions)										
Accuracy ⁷⁾	% of span	≤ 0.25 {0.125} ⁸⁾ (BFSL)										
	% of span	≤ 0.5 {0.25} ⁸⁾ (limit point calibration)										
		⁷⁾ Including linearity, hysteresis and repeatability.										
		Limit point calibration in vertical mounting position with lower pressure connection.										
		⁸⁾ Accuracy { } for pressure ranges ≥ 0.25 bar										
Reproducibility	% of span	≤ 0.05										
1-year stability	% of span	≤ 0.2 (at reference conditions)										
Permissible temperature of												
■ Medium ⁹⁾		-30 ... +100 °C {-40 ... +125 °C}					-22 ... +212 °F {-40 ... +257 °F}					
		S-11 with cooling element: -20 ... +150 °C					S-11 with cooling element: -4 ... +302 °F					
■ Ambient ⁹⁾		-20 ... +80 °C					-4 ... +176 °F					
		S-11 with cooling element: -20 ... +80 °C					S-11 with cooling element: -4 ... +176 °F					
■ Storage ⁹⁾		-40 ... +100 °C					-40 ... +212 °F					
		S-11 with cooling element: -20 ... +100 °C					S-11 with cooling element: -4 ... +212 °F					
		⁹⁾ Also complies with EN 50178, Tab. 7, Type C, Class 4KH Operation, 1K4 Storage, 1K3 Transport										
Compensated temp. range		0 ... +80 °C					32 ... +176 °F					
Temperature coefficients in compensated temp range												
■ Mean TC of zero	% of span	≤ 0.2 / 10 K (< 0.4 for pressure range < 250 mbar)										
■ Mean TC of range	% of span	≤ 0.2 / 10 K										
CE- conformity		89/336/EWG interference emission and immunity see EN 61 326, interference emission limit class A and B, 97/23/EG Pressure equipment directive (Module H)										
Shock resistance	g	1000 according to IEC 60068-2-27 (mechanical shock)										
Vibration resistance	g	20 according to IEC 60068-2-6 (vibration under resonance)										
Wiring protection		Protected against reverse polarity, overvoltage and short circuiting										
Weight	kg	Approx. 0.2 / Approx. 0.3 with option accuracy 0.25% of span due to longer case										

{ } Items in curved brackets { } are optional extras for additional price.

Dimensions in mm

Electrical connections

Ingress Protection IP per IEC 60 529

L-connector,
DIN EN 175301-803, Form A
for conductor cross section
up to max. 1.5 mm²,
conductor outer diameter
6 - 8 mm,
IP 65
Order code: A4

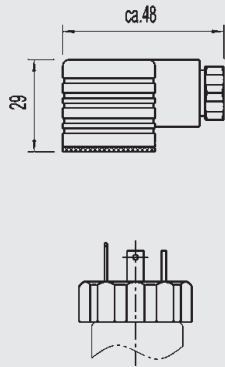

Circular connector
M 12x1, 4-pin,
IP 67
Order code: M4

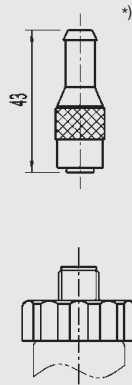

Flying leads
conductor cross section up
to max. 0.5 mm² /
AWG 20 with end splices,
conductor outer diameter
6.8 mm, IP 67
Order code: DL

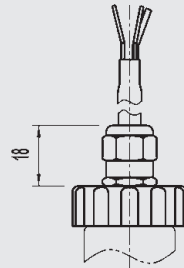

Flying leads, zero/span not adjustable
,
conductor cross section up to max.
0.5 mm² / AWG 20 with end splices,
conductor outer diameter 6.8 mm,
IP 68
Order code: EM

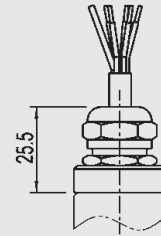

Others on request

Case

Case at 0.25 %
accuracy

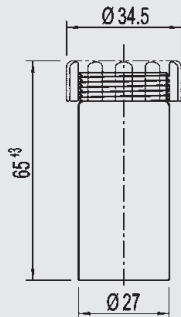

Case at 0.5 %
accuracy

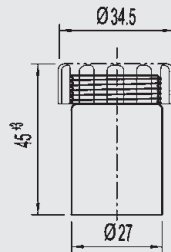

Case at 0.25 %
accuracy

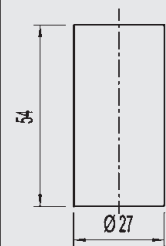

Case at 0.5 %
accuracy

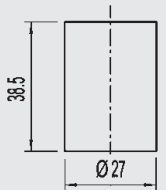

Pressure connections S-10

G 1/2
EN 837
Order code: GD

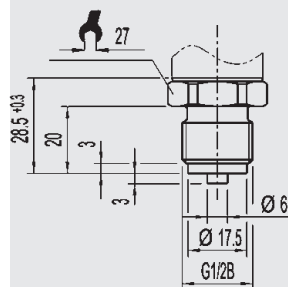

G 1/4
EN 837
Order code: GB

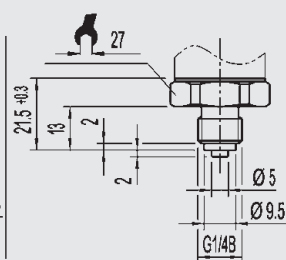

G 1/4
DIN 3852-E
Order code: HD

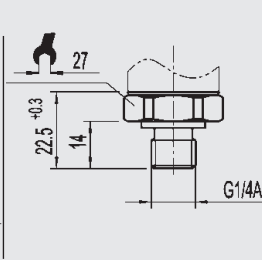

1/2 NPT
per „Nominal size for US
standard tapered
pipe thread NPT“
Order code: ND

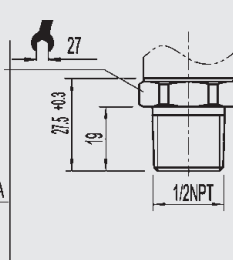

1/4 NPT
per „Nominal size for
US standard tapered
pipe thread NPT“
Order code: NB

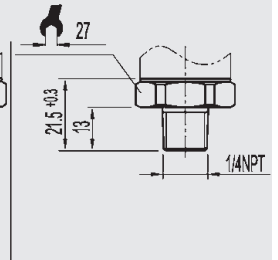

Others on request

For tapped holes and welding sockets please see Technical Information IN 00.14 for download at www.wika.de
-Service

*) Connectors are not included in delivery

Dimensions in mm

Pressure connections S-11, flush diaphragm

G 1/2 B
with or without cooling element
0 ... 2.5 up to 0 ... 600 bar
Order code: 86

G 1 B
with or without cooling element
0 ... 0.1 up to 0 ... 1.6 bar
Order code: 85

G 1 B
acc. EHEDG **)
with cooling element, up to 150 °C
up to 25 bar
Order code: 84

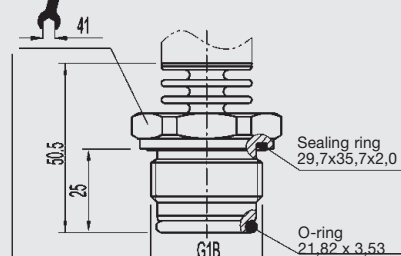
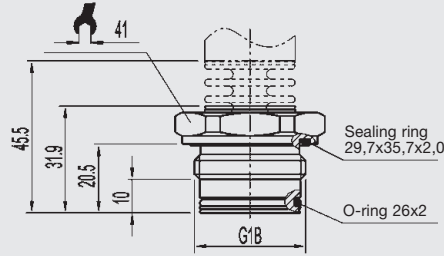
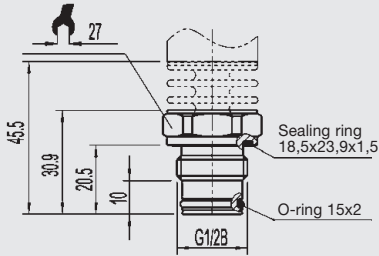

Others on request



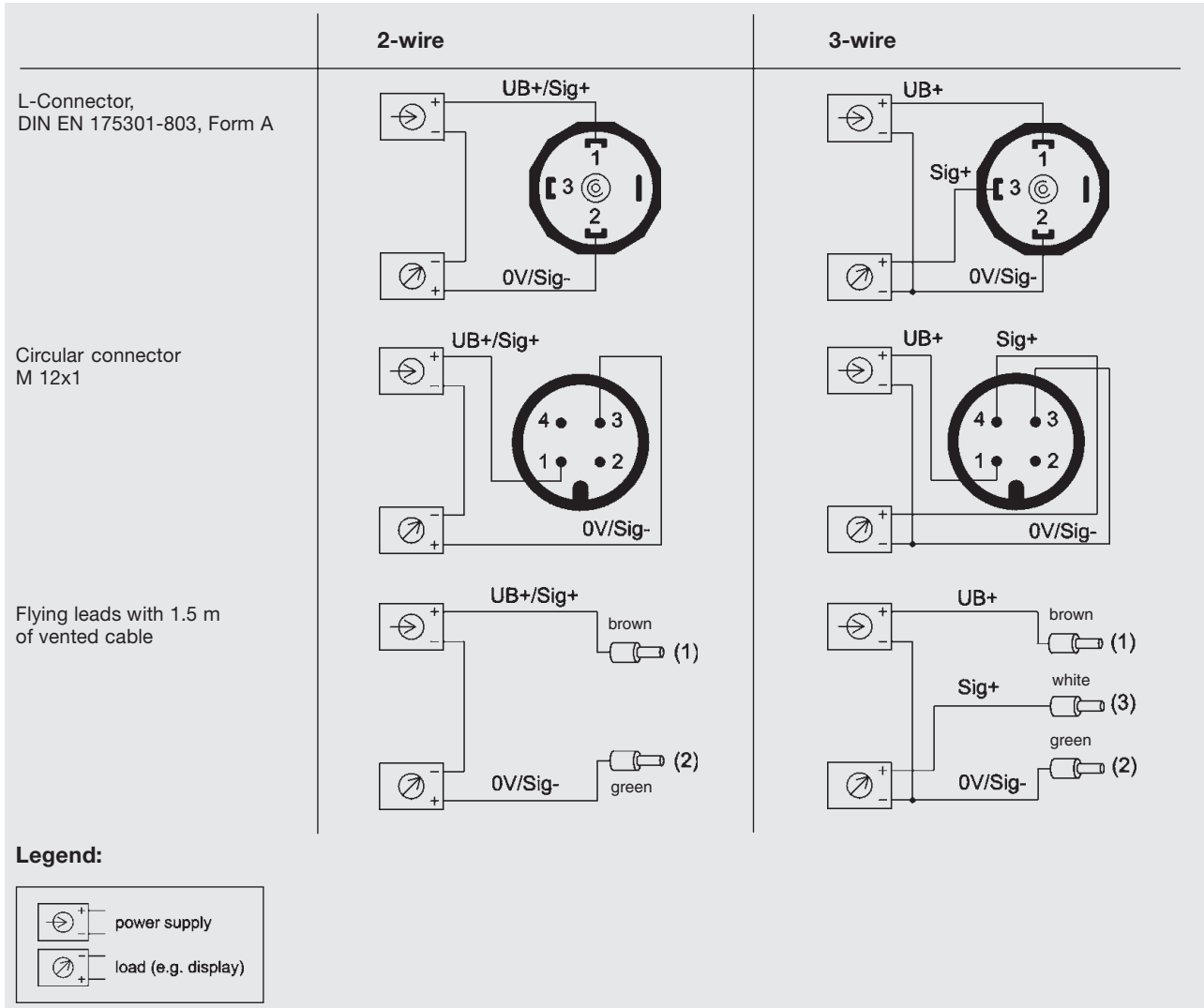

For tapped holes and welding sockets please see Technical Information IN 00.14 for download at www.wika.de
-Service

** European Hygienic Equipment Design Group

Wiring details



Accessories

Order-No.		
		S-11
	11 92 299	G 1/2 Weld-on adaptor
	11 92 264	G 1 Weld-on adaptor
		S-10
	90 92 099	G 1/2 WIKA-sealing
	90 92 161	G 1/4 WIKA-sealing
	16 04 791	S-10 G 1/2 Cooling element
	90 92 005	S-10 G 1/2 Adaptor with insert filter
	90 91 262	S-10 G 1/2 Throttle, max. 400 bar

Further informations

You can obtain further information (data sheets, instructions, etc.) via Internet address www.wika.de.



The screenshot displays the Wika website interface. On the left, there are navigation links for 'Press Releases', 'WIKA News', and 'Trade Shows'. The main content area features several news items:

- WIKA as Global Supplier for BASF**: WIKA has once again been named "Global Supplier" for the subsegments pressure measurement and temperature measurement by BASF. This status was first granted on 01st April 2012.
- T24 opens up new markets**: The new configuration software for the analogue temperature transmitter T24 is presenting a multitude of new applications through two new user languages (Japanese and Russian) as well as enhanced functionalities.
- Simple and precise**: The new Calibrator/Ind CP15000 from WIKA is the perfect addition to any pressure balance.
- MSI 2 pressure transmitters**: The MS1 product line has now also been granted the e1 type approval from the German Federal Bureau for Motor Vehicles.

On the right side, there is a technical drawing of a pressure transmitter with the label 'S-10 / S-11' and 'Operating instructions Druckmessumformer Transmetteur de pression'. Below this, there is a 'WIKA' logo and the text 'Part of your business'.

Specifications and dimensions given in this leaflet represent the state of engineering at the time of printing. Modifications may take place and materials specified may be replaced by others without prior notice.



WIKA Alexander Wiegand GmbH & Co. KG
 Alexander-Wiegand-Straße 30
 63911 Klingenberg/Germany
 Phone (+49) 93 72/132-0
 Telefax (+49) 93 72/132-406
 E-Mail support-tronic@wika.de
www.wika.de