

MODEL PAXDP – 1/8 DIN DUAL PROCESS INPUT METER



- ACCEPTS TWO 4 - 20 mA OR 0 - 10 VDC INPUT SIGNALS
- PROGRAMMABLE A/D CONVERSION RATE, 5 TO 105 READINGS PER SECOND
- 5-DIGIT 0.56" RED SUNLIGHT READABLE DISPLAY
- VARIABLE INTENSITY DISPLAY
- LINEARIZATION/SQUARE ROOT EXTRACTION INPUT RANGE
- PROGRAMMABLE FUNCTION KEYS/USER INPUTS
- 9 DIGIT TOTALIZER (INTEGRATOR) WITH BATCHING
- OPTIONAL CUSTOM UNITS OVERLAY W/BACKLIGHT
- FOUR SETPOINT ALARM OUTPUTS (W/OPTION CARD)
- COMMUNICATION AND BUS CAPABILITIES (W/OPTION CARD)
- RETRANSMITTED ANALOG OUTPUT (W/OPTION CARD)
- NEMA 4X/IP65 SEALED FRONT BEZEL
- PC SOFTWARE AVAILABLE FOR METER CONFIGURATION

GENERAL DESCRIPTION

The PAXDP Dual Process Input Meter offers many features and performance capabilities to suit a wide range of industrial applications. Available in two models, AC or DC power, the meter has the capability to accept two, 4 to 20 mA or 0 to 10 VDC input signals. Each input signal can be independently scaled and displayed. In addition, a math function can be performed on the two signals, C + A + B, C - A - B, C + A - B, AB / C, CA / B, or C (A / B - 1). Any of the three meter values can have Alarms, Comms, and/or a Retrmitted Analog Output capability by simply adding optional cards. The optional plug-in output cards allow the opportunity to configure the meter for current applications, while providing easy upgrades for future needs.

The update rate of the meter is user selectable. This will help in those applications where a quick response from the meter is of the utmost importance. The rate can be adjusted from eight selections with a minimum of 5 updates/second to a maximum of 105 updates/second.

The meters employ a bright 0.56" (14.2 mm) red sunlight readable LED display. The intensity of display can be adjusted from dark room applications up to sunlight readable, making it ideal for viewing in bright light applications.

The meters provide a MAX and MIN reading memory with programmable capture time. The capture time is used to prevent detection of false max or min readings which may occur during start-up or unusual process events.

The signal totalizer (integrator) can be used to compute a time-input product. This can be used to provide a readout of totalized flow, calculate service intervals of motors or pumps, etc. The totalizer can also accumulate batch operations.

The meter has four setpoint outputs, implemented on Plug-in option cards. The Plug-in cards provide dual FORM-C relays (5A), quad FORM-A (3A), or either quad sinking or quad sourcing open collector logic outputs. The setpoint alarms can be configured to suit a variety of control and alarm requirements.

Communication and Bus Capabilities are also available as option cards. The standard output is in Modbus Protocol. Any of the following option cards, RS232, RS485, DeviceNet, or Profibus can be used with the meter. Readout values and setpoint alarm values can be controlled through the bus. Additionally, the meters have a feature that allows a remote computer to directly control the outputs of the meter.

A linear DC output signal is available as an optional Plug-in card. The card provides either 20 mA or 10 V signals. The output can be scaled independent of the input range and can track either the input, totalizer, max/min readings, or math calculation value.

Once the meters have been initially configured, the parameter list may be locked out from further modification in its entirety or only the setpoint values can be made accessible.

The meters have been specifically designed for harsh industrial environments. With NEMA 4X/IP65 sealed bezel and extensive testing of noise effects to CE requirements, the meter provides a tough yet reliable application solution.

SAFETY SUMMARY

All safety related regulations, local codes and instructions that appear in this literature or on equipment must be observed to ensure personal safety and to prevent damage to either the instrument or equipment connected to it. If equipment is used in a manner not specified by the manufacturer, the protection provided by the equipment may be impaired.

Do not use this unit to directly command motors, valves, or other actuators not equipped with safeguards. To do so can be potentially harmful to persons or equipment in the event of a fault to the unit.



CAUTION: Read complete instructions prior to installation and operation of the unit.



CAUTION: Risk of electric shock.

DIMENSIONS In inches (mm)

Note: Recommended minimum clearance (behind the panel) for mounting clip installation is 2.1" (53.4) H x 5.0" (127) W.

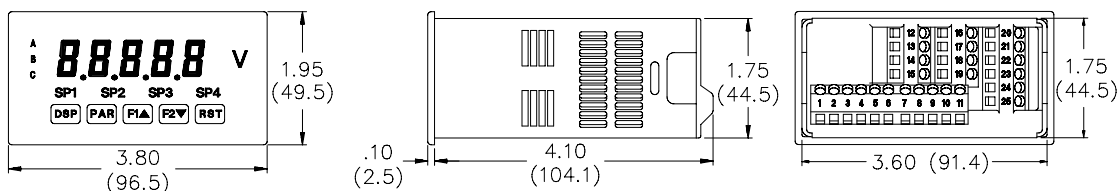
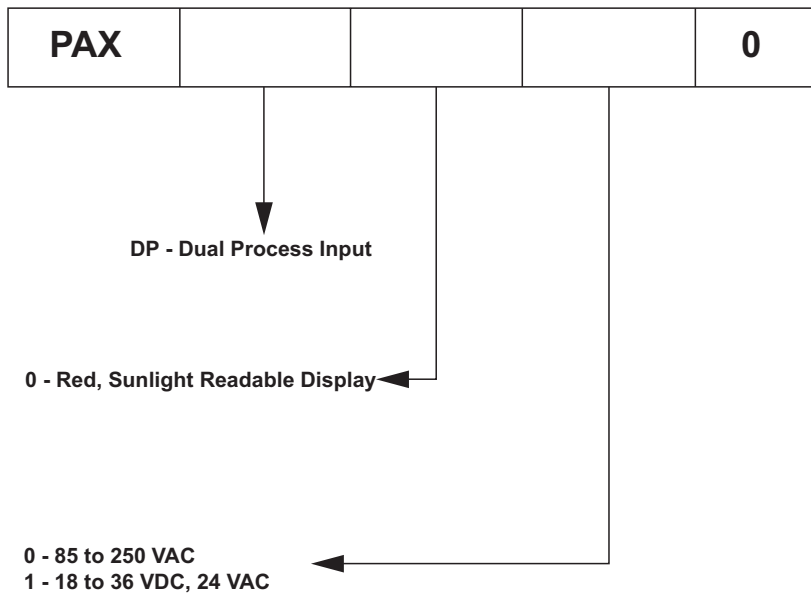

TABLE OF CONTENTS

Ordering Information	2	Wiring the Meter	7
General Meter Specifications	3	Reviewing the Front Buttons and Display . . .	9
Accessories	4	Programming the Meter	10
Optional Plug-In Cards	5	Factory Service Operations	30
Installing the Meter	6	Parameter Value Chart	32
Setting the Jumpers	6	Programming Overview	34

ORDERING INFORMATION

Meter Part Numbers



Option Card and Accessories Part Numbers

TYPE	MODEL NO.	DESCRIPTION	PART NUMBERS
Optional Plug-In Cards	PAXCDS	Dual Setpoint Relay Output Card	PAXCDS10
		Quad Setpoint Relay Output Card	PAXCDS20
		Quad Setpoint Sinking Open Collector Output Card	PAXCDS30
		Quad Setpoint Sourcing Open Collector Output Card	PAXCDS40
	PAXCDC	RS485 Serial Communications Output Card with Terminal Block	PAXCDC10
		Extended RS485 Serial Communications Output Card with Dual RJ11 Connector	PAXCDC1C
		RS232 Serial Communications Output Card with Terminal Block	PAXCDC20
		Extended RS232 Serial Communications Output Card with 9 Pin D Connector	PAXCDC2C
		DeviceNet Communications Card	PAXCDC30
		Profibus-DP Communications Card	PAXCDC50
PAXCDL	Analog Output Card	PAXCDL10	
Accessories	PAXLBK	Units Label Kit Accessory	PAXLBK10
	SFCRD	Crimson 2 PC Configuration Software for Windows 98, ME, 2000, XP ²	SFCRD200

Notes:
 1. For Modbus communications use RS485 Communications Output Card and configure communication (**TYPE**) parameter for Modbus.
 2. Crimson 2 software is available for download at <http://www.redlion.net/>

GENERAL METER SPECIFICATIONS

1. **DISPLAY:** 5 digit, 0.56" (14.2 mm) variable intensity red sunlight readable (-19999 to 99999)

2. **POWER:**

AC Versions:

AC Power: 85 to 250 VAC, 50/60 Hz, 21 VA

Isolation: 2300 Vrms for 1 min. to all inputs and outputs.

DC Versions: (Derate operating temperature to 40° C if three plug-in option cards or PAXCDC50 are installed.)

DC Power: 18 to 36 VDC, 13 W

AC Power: 24 VAC, ± 10%, 50/60 Hz, 16 VA

Isolation: 500 Vrms for 1 min. to all inputs and outputs (50 V working).

Must use a Class 2 or SELV rated power supply

3. **ANNUNCIATORS:**

A - Programmable Display

B - Programmable Display

C - Programmable Display

SP1 - Setpoint alarm 1 is active

SP2 - Setpoint alarm 2 is active

SP3 - Setpoint alarm 3 is active

SP4 - Setpoint alarm 4 is active

Units Label - Optional units label backlight

4. **KEYPAD:** 3 programmable function keys, 5 keys total

5. **A/D CONVERTER:** 16 bit resolution

6. **UPDATE RATES:**

A/D conversion rate: Adjustable 5.3 to 105 readings/sec.

Step response: (to within 99% of final readout value with digital filter disabled)

INPUT UPDATE RATE	MAX. TIME (msec)
5.3	770
7.5	560
16.7	260
19.8	220
20	220
30	150
105	60

Display update rate: adjustable 1 to 20 readings/sec.

Setpoint output on/off delay time: 0 to 3275 sec.

Analog output update rate: 0 to 10 sec

Max./Min. capture delay time: 0 to 3275 sec.

7. **DISPLAY MESSAGES:**

“OLOL” - Appears when measurement exceeds + signal range.

“ULUL” - Appears when measurement exceeds - signal range

“...” - Appears when display values exceed + display range.

“-...” - Appears when display values exceed - display range.

8. **SENSOR INPUTS:**

INPUT (RANGE)	ACCURACY* (18 to 28°C)	ACCURACY* (0 to 50°C)	IMPEDANCE/ COMPLIANCE	MAX CONTINUOUS OVERLOAD	DISPLAY RESOLUTION
±20 mA (-26 to 26 mA)	0.03% of reading +2 µA	0.12% of reading +3 µA	24.6 ohm	90 mA	1 µA
±10 VDC (-13 to 13 VDC)	0.03% of reading +2 mV	0.12% of reading +3 mV	500 Kohm	50 V	1 mV

* After 20 minute warm-up. Accuracy is specified in two ways: Accuracy over an 18 to 28°C and 10 to 75% RH environment; and accuracy over a 0 to 50°C and 0 to 85% RH (non-condensing environment). Accuracy over the 0 to 50°C range includes the temperature coefficient effect of the meter.

9. **EXCITATION POWER:**

Transmitter Power: 18 VDC, ±20%, unregulated, 70 mA max. per input channel.

10. **LOW FREQUENCY NOISE REJECTION:**

Normal Mode: (digital filter off)

INPUT UPDATE RATE	50 Hz ±1 Hz	60 Hz ±1 Hz
5.3	>90 dB	>65 dB
7.5	>60 dB	>55 dB
16.7	>100 dB	>50 dB
19.8*	>60 dB	>95 dB
20	>55 dB	>100 dB
30	>20 dB	>20 dB
105	>20 dB	>13 dB

*Note: 19.8 Hz Input Rate provides best rate performance and simultaneous 50/60 Hz rejection.

Common Mode: >100 dB @ 50/60 ±1 Hz (19.8 or 20 Input Rate)

11. **USER INPUTS:** Three programmable user inputs

Max. Continuous Input: 30 VDC

Isolation To Sensor Input A Common: 500 Vrms for 1 min;

Working Voltage: 50 V

Isolation To Sensor Input B Common: Not isolated.

INPUT STATE	SINKING INPUTS 22 KΩ pull-up to +5 V	SOURCING INPUTS 22 KΩ pull-down
Active	V _{IN} < 0.9 VDC	V _{IN} > 3.6 VDC
Inactive	V _{IN} > 3.6 VDC	V _{IN} < 0.9 VDC

Response Time: 20 msec. max.

Logic State: Jumper selectable for sink/source logic

12. **TOTALIZER:**

Function:

Time Base: second, minute, hour, or day

Batch: Can accumulate (gate) input display from a user input

Time Accuracy: 0.01% typical

Decimal Point: 0 to 0.0000

Scale Factor: 0.001 to 65.000

Low Signal Cut-out: -19,999 to 99,999

Total: 9 digits, display alternates between high order and low order readouts

13. **CUSTOM LINEARIZATION:**

Data Point Pairs: Selectable from 2 to 16

Display Range: -19,999 to 99,999

Decimal Point: 0 to 0.0000

14. **MEMORY:** Nonvolatile memory retains all programmable parameters and display values.

15. **CERTIFICATIONS AND COMPLIANCES:**

SAFETY

UL Recognized Component, File #E179259, UL3101-1, CSA C22.2 No. 1010-1

Recognized to U.S. and Canadian requirements under the Component Recognition Program of Underwriters Laboratories, Inc.

UL Listed, File #E137808, UL508, CSA C22.2 No. 14-M95

LISTED by Und. Lab. Inc. to U.S. and Canadian safety standards

Type 4X Enclosure rating (Face only), UL50

IECEE CB Scheme Test Certificate #US/7470B/UL

CB Scheme Test Report #03ME09282-08292003

Issued by Underwriters Laboratories, Inc.

IEC 1010-1, EN 61010-1: Safety requirements for electrical equipment for measurement, control, and laboratory use, Part 1.

IP65 Enclosure rating (Face only), IEC 529

IP20 Enclosure rating (Rear of unit), IEC 529

15. CERTIFICATIONS AND COMPLIANCES (Cont'd):

ELECTROMAGNETIC COMPATIBILITY

Emissions and Immunity to EN 61326: Electrical Equipment for Measurement, Control and Laboratory use.

Immunity to Industrial Locations:

Electrostatic discharge	EN 61000-4-2	Criterion A 4 kV contact discharge 8 kV air discharge
Electromagnetic RF fields	EN 61000-4-3	Criterion A 10 V/m
Fast transients (burst)	EN 61000-4-4	Criterion A 2 kV power 1 kV signal
Surge	EN 61000-4-5	Criterion A 1 kV L-L, 2 kV L&N-E power
Voltage dip/interruptions	EN 61000-4-11	Criterion A 0.5 cycle
RF conducted interference	EN 61000-4-6	Criterion A 3 V/rms
Emissions:		
AC powered	EN 55011	Class B
DC powered	EN 55011	Class A

Notes:

1. *Criterion A: Normal operation within specified limits.*
2. *Criterion B: Temporary loss of performance from which the unit self-recovers.*

Refer to EMC Installation Guidelines section of the bulletin for additional information.

16. ENVIRONMENTAL CONDITIONS:

Operating Temperature Range: 0 to 50°C (0 to 45°C with all three plug-in option cards installed)

Storage Temperature Range: -40 to 60°C

Operating and Storage Humidity: 0 to 85% max. RH non-condensing
Altitude: Up to 2000 meters

17. CONNECTIONS: High compression cage-clamp terminal block

Wire Strip Length: 0.3" (7.5 mm)

Wire Gauge: 30-14 AWG copper wire

Torque: 4.5 inch-lbs (0.51 N-m) max.

18. CONSTRUCTION: This unit is rated for NEMA 4X/IP65 outdoor use. IP20 Touch safe. Installation Category II, Pollution Degree 2. One piece bezel/case. Flame resistant. Synthetic rubber keypad. Panel gasket and mounting clip included.

19. WEIGHT: 10.4 oz. (295 g)

ACCESSORIES

UNITS LABEL KIT (PAXLBK)

Each meter has a units indicator with backlighting that can be customized using the Units Label Kit. The backlight is controlled in the programming.

PROGRAMMING SOFTWARE

Crimson 2 (SFCRM2) is a Windows® based program for configuring and updating the firmware of the PAXDP meter from a PC. Using Crimson 2 makes programming the PAXDP meter easier and allows the user to save the PAXDP database in a PC file for future use. Crimson is available as a free download from Red Lion's website, or it can be purchased on CD.

The first time Crimson 2 is run from the File menu, select "New" to display a dialog and select the PAXDP. The screen will display icons that represent the various programming sections of the PAXDP. Double-click on an icon to configure the programming parameters pertaining to the selection. Tool Tip help is available for each of the program parameters. A PAX serial plug-in card is required to program the meter using the software.

OPTIONAL PLUG-IN OUTPUT CARDS



WARNING: Disconnect all power to the unit before installing Plug-in cards.

Adding Option Cards

The PAX and MPAX series meters can be fitted with up to three optional plug-in cards. The details for each plug-in card can be reviewed in the specification section below. Only one card from each function type can be installed at one time. The function types include Setpoint Alarms (PAXCDS), Communications (PAXCDC), and Analog Output (PAXCDL). The plug-in cards can be installed initially or at a later date.

COMMUNICATION CARDS (PAXCDC)

A variety of communication protocols are available for the PAX and MPAX series. Only one of these cards can be installed at a time. *Note: For Modbus communications use RS485 Communications Output Card and configure communication (kYPE) parameter for Modbus.*

- PAXCDC10 - RS485 Serial (Terminal Block)
- PAXCDC1C - RS485 Serial (Dual RJ11 Connector)
- PAXCDC20 - RS232 Serial (Terminal Block)
- PAXCDC2C - RS232 Serial (9 Pin D Connector)
- PAXCDC30 - DeviceNet
- PAXCDC50 - Profibus-DP

SERIAL COMMUNICATIONS CARD

Type: RS485 or RS232

Isolation To Sensor & User Input Commons: 500 Vrms for 1 min.

Working Voltage: 50 V. Not Isolated from all other commons.

Baud: 300 to 38,400

Data: 7/8 bits

Parity: no, odd or even

Bus Address: Selectable 0 to 99 (RLC Protocol), or 1 to 247 (Modbus Protocol), Max. 32 meters per line (RS485)

Transmit Delay: Selectable for 0 to 0.250 sec (+2 msec min)

DEVICENET™ CARD

Compatibility: Group 2 Server Only, not UCMM capable

Baud Rates: 125 Kbaud, 250 Kbaud, and 500 Kbaud

Bus Interface: Phillips 82C250 or equivalent with MIS wiring protection per DeviceNet™ Volume I Section 10.2.2.

Node Isolation: Bus powered, isolated node

Host Isolation: 500 Vrms for 1 minute (50 V working) between DeviceNet™ and meter input common.

PROFIBUS-DP CARD

Fieldbus Type: Profibus-DP as per EN 50170, implemented with Siemens SPC3 ASIC

Conformance: PNO Certified Profibus-DP Slave Device

Baud Rates: Automatic baud rate detection in the range 9.6 Kbaud to 12 Mbaud

Station Address: 0 to 126, set by the master over the network. Address stored in non-volatile memory.

Connection: 9-pin Female D-Sub connector

Network Isolation: 500 Vrms for 1 minute (50 V working) between Profibus network and sensor and user input commons. Not isolated from all other commons.

SETPOINT CARDS (PAXCDS)

The PAX and MPAX series has 4 available setpoint alarm output plug-in cards. Only one of these cards can be installed at a time. (Logic state of the outputs can be reversed in the programming.) These plug-in cards include:

- PAXCDS10 - Dual Relay, FORM-C, Normally open & closed
- PAXCDS20 - Quad Relay, FORM-A, Normally open only
- PAXCDS30 - Isolated quad sinking NPN open collector
- PAXCDS40 - Isolated quad sourcing PNP open collector

DUAL RELAY CARD

Type: Two FORM-C relays

Isolation To Sensor & User Input Commons: 2000 Vrms for 1 min.

Working Voltage: 240 Vrms

Contact Rating:

One Relay Energized: 5 amps @ 120/240 VAC or 28 VDC (resistive load), 1/8 HP @120 VAC, inductive load

Total current with both relays energized not to exceed 5 amps

Life Expectancy: 100 K cycles min. at full load rating. External RC snubber extends relay life for operation with inductive loads

QUAD RELAY CARD

Type: Four FORM-A relays

Isolation To Sensor & User Input Commons: 2300 Vrms for 1 min.

Working Voltage: 250 Vrms

Contact Rating:

One Relay Energized: 3 amps @ 240 VAC or 30 VDC (resistive load), 1/10 HP @120 VAC, inductive load

Total current with all four relays energized not to exceed 4 amps

Life Expectancy: 100 K cycles min. at full load rating. External RC snubber extends relay life for operation with inductive loads

QUAD SINKING OPEN COLLECTOR CARD

Type: Four isolated sinking NPN transistors.

Isolation To Sensor & User Input Commons: 500 Vrms for 1 min.

Working Voltage: 50 V. Not Isolated from all other commons.

Rating: 100 mA max @ $V_{SAT} = 0.7 V$ max. $V_{MAX} = 30 V$

QUAD SOURCING OPEN COLLECTOR CARD

Type: Four isolated sourcing PNP transistors.

Isolation To Sensor & User Input Commons: 500 Vrms for 1 min.

Working Voltage: 50 V. Not Isolated from all other commons.

Rating: Internal supply: 24 VDC $\pm 10\%$, 30 mA max. total

External supply: 30 VDC max., 100 mA max. each output

ALL FOUR SETPOINT CARDS

Response Time: See update rates step response specification; add 6 msec (typical) for relay card

LINEAR DC OUTPUT (PAXCDL)

Either a 0(4)-20 mA or 0-10 V retransmitted linear DC output is available from the analog output plug-in card. The programmable output low and high scaling can be based on various display values. Reverse slope output is possible by reversing the scaling point positions.

PAXCDL10 - Retransmitted Analog Output Card

ANALOG OUTPUT CARD

Types: 0 to 20 mA, 4 to 20 mA or 0 to 10 VDC

Isolation To Sensor & User Input Commons: 500 Vrms for 1 min.

Working Voltage: 50 V. Not Isolated from all other commons.

Accuracy: 0.17% of FS (18 to 28°C); 0.4% of FS (0 to 50°C)

Resolution: 1/3500

Compliance: 10 VDC: 10 K Ω load min., 20 mA: 500 Ω load max.

Update time: See update rates step response specification

1.0 INSTALLING THE METER

Installation

The PAX meets NEMA 4X/IP65 requirements when properly installed. The unit is intended to be mounted into an enclosed panel. Prepare the panel cutout to the dimensions shown. Remove the panel latch from the unit. Slide the panel gasket over the rear of the unit to the back of the bezel. The unit should be installed fully assembled. Insert the unit into the panel cutout.

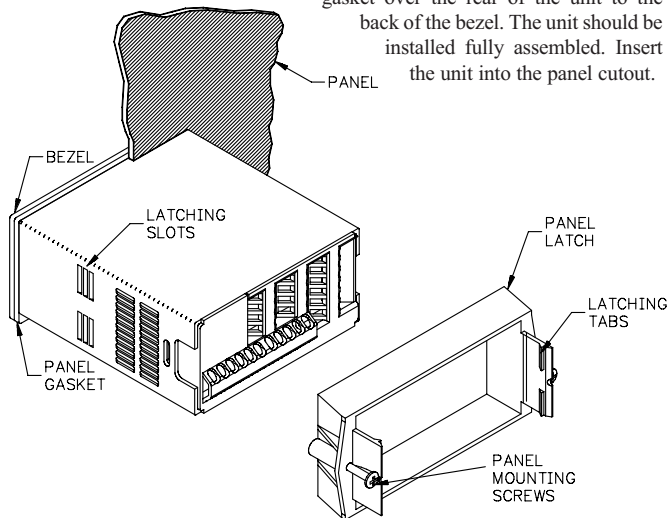

While holding the unit in place, push the panel latch over the rear of the unit so that the tabs of the panel latch engage in the slots on the case. The panel latch should be engaged in the farthest forward slot possible. To achieve a proper seal, tighten the latch screws evenly until the unit is snug in the panel (Torque to approximately 7 in-lbs [79N-cm]). Do not over-tighten the screws.

Installation Environment

The unit should be installed in a location that does not exceed the maximum operating temperature and provides good air circulation. Placing the unit near devices that generate excessive heat should be avoided.

The bezel should be cleaned only with a soft cloth and neutral soap product. Do NOT use solvents. Continuous exposure to direct sunlight may accelerate the aging process of the bezel.

Do not use tools of any kind (screwdrivers, pens, pencils, etc.) to operate the keypad of the unit.

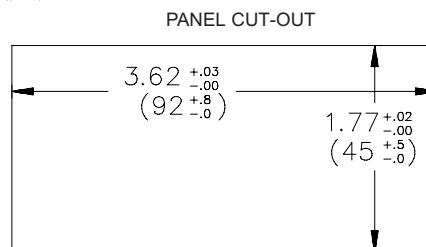

2.0 SETTING THE JUMPERS

The meter has three jumpers that must be checked and/or changed prior to applying power. The following Jumper Selection Figures show an enlargement of the jumper area.

To access the jumpers, remove the meter base from the case by firmly squeezing and pulling back on the side rear finger tabs. This should lower the latch below the case slot (which is located just in front of the finger tabs). It is recommended to release the latch on one side, then start the other side latch.

Input Jumpers

These jumpers are used to select the proper input types, Voltage (V) or Current (I). The input type selected in programming must match the jumper setting. See the Jumper Selection Figures for more details.

User Input Logic Jumper

This jumper selects the logic state of all the user inputs. If the user inputs are not used, it is not necessary to check or move this jumper.

PAXDP Jumper Selection

JUMPER SELECTIONS

The indicates factory setting.

INPUT A	INPUT B	USER INPUT
VOLT/CURRENT	VOLT/CURRENT	
<input type="checkbox"/> CURRENT (I)	<input type="checkbox"/> CURRENT (I)	<input type="checkbox"/> SINK
<input type="checkbox"/> VOLTAGE (V)	<input type="checkbox"/> VOLTAGE (V)	<input type="checkbox"/> SOURCE (SRC)

Note: In the figures above, the text shown in parenthesis is printed on the circuit board to help with proper jumper positioning.

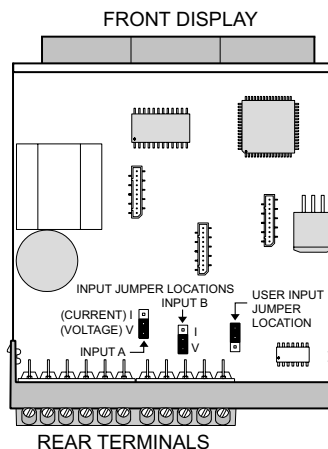

3.0 WIRING THE METER

WIRING OVERVIEW

Electrical connections are made via screw-clamp terminals located on the back of the meter. All conductors should conform to the meter's voltage and current ratings. All cabling should conform to appropriate standards of good installation, local codes and regulations. It is recommended that power supplied to the meter (DC or AC) be protected by a fuse or circuit breaker.

When wiring the meter, compare the numbers embossed on the back of the meter case against those shown in wiring drawings for proper wire position. Strip the wire, leaving approximately 0.3" (7.5 mm) bare lead exposed (stranded wires should be tinned with solder). Insert the lead under the correct screw-clamp terminal and tighten until the wire is secure. (Pull wire to verify tightness.) Each terminal can accept up to one #14 AWG (2.55 mm) wire, two #18 AWG (1.02 mm), or four #20 AWG (0.61 mm).

EMC INSTALLATION GUIDELINES

Although this meter is designed with a high degree of immunity to Electro-Magnetic Interference (EMI), proper installation and wiring methods must be followed to ensure compatibility in each application. The type of the electrical noise, its source or the method of coupling into the unit may be different for various installations. Listed below are some EMC guidelines for successful installation in an industrial environment.

1. The meter should be mounted in a metal enclosure, which is properly connected to protective earth.
2. With use of the lower input ranges or signal sources with high source impedance, the use of shielded cable may be necessary. This helps to guard against stray AC pick-up. Attach the shield to the input common of the meter.
3. To minimize potential noise problems, power the meter from the same power branch, or at least the same phase voltage as that of the signal source.
4. Never run Signal or Control cables in the same conduit or raceway with AC power lines, conductors feeding motors, solenoids, SCR controls, and

heaters, etc. The cables should be run in metal conduit that is properly grounded. This is especially useful in applications where cable runs are long and portable two-way radios are used in close proximity or if the installation is near a commercial radio transmitter.

5. Signal or Control cables within an enclosure should be routed as far away as possible from contactors, control relays, transformers, and other noisy components.
6. In extremely high EMI environments, the use of external EMI suppression devices, such as ferrite suppression cores, is effective. Install them on Signal and Control cables as close to the unit as possible. Loop the cable through the core several times or use multiple cores on each cable for additional protection. Install line filters on the power input cable to the unit to suppress power line interference. Install them near the power entry point of the enclosure. The following EMI suppression devices (or equivalent) are recommended:

Ferrite Suppression Cores for signal and control cables:

Fair-Rite # 0443167251 (RLC #FCOR0000)

TDK # ZCAT3035-1330A

Steward #28B2029-0A0

Line Filters for input power cables:

Schaffner # FN610-1/07 (RLC #LFIL0000)

Schaffner # FN670-1.8/07

Corcom #1VR3

Note: Reference manufacturer's instructions when installing a line filter.

7. Long cable runs are more susceptible to EMI pickup than short cable runs. Therefore, keep cable runs as short as possible.
8. Switching of inductive loads produces high EMI. Use of snubbers across inductive loads suppresses EMI.
Snubber: RLC#SNUB0000.

3.1 POWER WIRING

AC Power

Terminal 1: VAC

Terminal 2: VAC

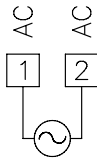

DC Power

Terminal 1: +VDC

Terminal 2: -VDC

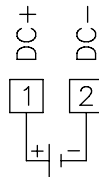

3.2 INPUT SIGNAL WIRING

Before connecting signal wires, the Input Range Jumper must be verified for proper position.

INPUT A SIGNAL WIRING

Voltage Signal (self powered)

Terminal 4: -VDC
Terminal 5: +VDC

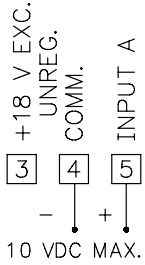

Current Signal (self powered)

Terminal 4: -ADC
Terminal 5: +ADC

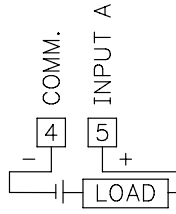

Current Signal (2 wire requiring excitation)

Terminal 3: +ADC
Terminal 5: -ADC

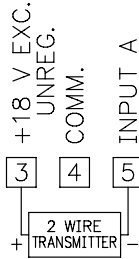

Voltage/Current Signal (3 wire requiring excitation)

Terminal 3: +VOLT supply
Terminal 4: -ADC (common)
Terminal 5: +ADC (signal)

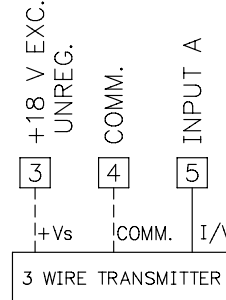

INPUT B SIGNAL WIRING

Voltage Signal (self powered)

Terminal 6: +VDC
Terminal 8: -VDC

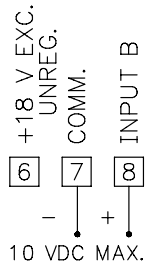

Current Signal (self powered)

Terminal 7: -ADC
Terminal 8: +ADC

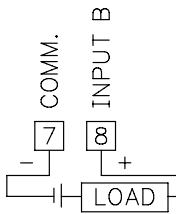

Current Signal (2 wire requiring excitation)

Terminal 6: +ADC
Terminal 8: -ADC

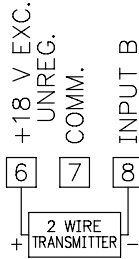

Voltage/Current Signal (3 wire requiring excitation)

Terminal 6: +VOLT supply
Terminal 7: -ADC (common)
Terminal 8: +ADC (signal)

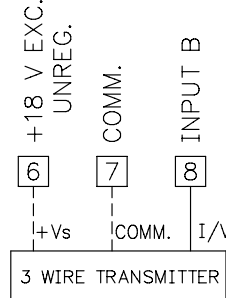

CAUTION: Sensor Input B common is NOT isolated from user input common. In order to preserve the safety of the meter application, the sensor input common must be suitably isolated from hazardous live earth referenced voltages; or input common must be at protective earth ground potential. If not, hazardous live voltage may be present at the User Inputs and User Input Common terminals. Appropriate considerations must then be given to the potential of the user input common with respect to earth common; and the common of the isolated plug-in cards with respect to input common.

3.3 USER INPUT WIRING

Before connecting the wires, the User Input Logic Jumper should be verified for proper position. If not using User Inputs, then skip this section. Only the appropriate User Input terminal has to be wired.

Sinking Logic

Terminal 9: } Connect external switching device between
Terminal 10-11: } appropriate User Input terminal and User Comm.

In this logic, the user inputs of the meter are internally pulled up to +5 V with 22 K resistance. The input is active when it is pulled low (<0.9 V).

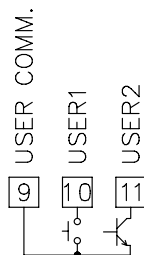

Sourcing Logic

Terminal 9: -VDC thru external switching device
Terminal 10-11: +VDC thru external switching device

In this logic, the user inputs of the meter are internally pulled down to 0 V with 22 K resistance. The input is active when a voltage greater than 3.6 VDC is applied.

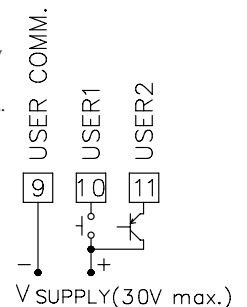

3.4 SETPOINT (ALARMS) WIRING

3.5 ANALOG OUTPUT WIRING



See appropriate plug-in card bulletin for details.

3.6 SERIAL COMMUNICATION WIRING

RS232 Communications

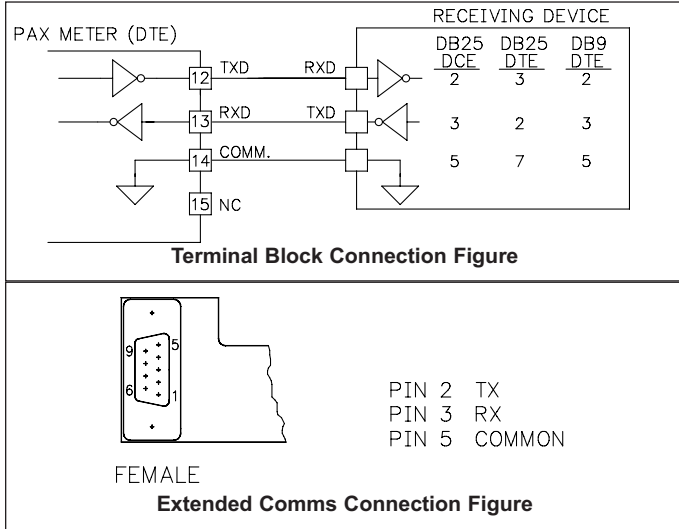

RS232 is intended to allow two devices to communicate over distances up to 50 feet. Data Terminal Equipment (DTE) transmits data on the Transmitted Data (TXD) line and receives data on the Received Data (RXD) line. Data Computer Equipment (DCE) receives data on the TXD line and transmits data on the RXD line. The PAX emulates a DTE. If the other device connected to the meter also emulates a DTE, the TXD and RXD lines must be interchanged for communications to take place. This is known as a null modem connection. Most printers emulate a DCE device while most computers emulate a DTE device.

Some devices cannot accept more than two or three characters in succession without a pause in between. In these cases, the meter employs a busy function.

As the meter begins to transmit data, the RXD line (RS232) is monitored to determine if the receiving device is "busy". The receiving device asserts that it is busy by setting the RXD line to a space condition (logic 0). The meter then suspends transmission until the RXD line is released by the receiving device.

RS485 Communications

The RS485 communication standard allows the connection of up to 32 devices on a single pair of wires, distances up to 4,000 ft. and data rates as high as 10M baud (the PAX is limited to 19.2k baud). The same pair of wires is used to both transmit and receive data. RS485 is therefore always half-duplex, that is, data cannot be received and transmitted simultaneously.

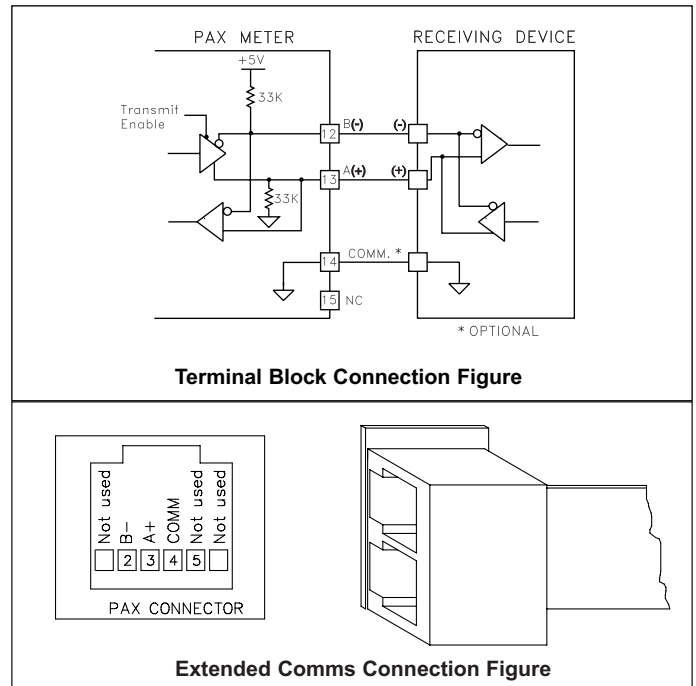

4.0 REVIEWING THE FRONT BUTTONS AND DISPLAY

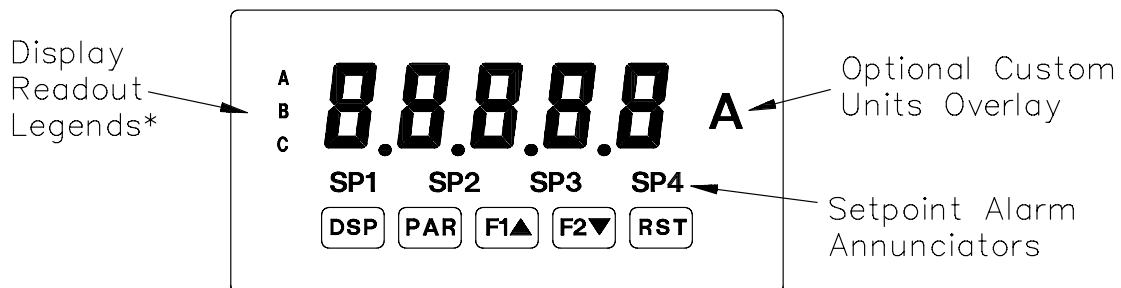

KEY DISPLAY MODE OPERATION

- DSP** Index display through main displays as programmed in 3-LOC
- PAR** Access parameter list
- F1▲** Function key 1; hold for 3 seconds for Second Function 1**
- F2▼** Function key 2; hold for 3 seconds for Second Function 2**
- RST** Reset (Function key)**

* Display Readout Legends may be locked out in Factory Settings.

** Factory setting for the F1, F2, and RST keys is NO mode.

PROGRAMMING MODE OPERATION

- Quit programming and return to display mode
- Store selected parameter and index to next parameter
- Increment selected parameter value
- Decrement selected parameter value
- Hold with F1▲, F2▼ to scroll value by x1000

5.0 PROGRAMMING THE METER

OVERVIEW

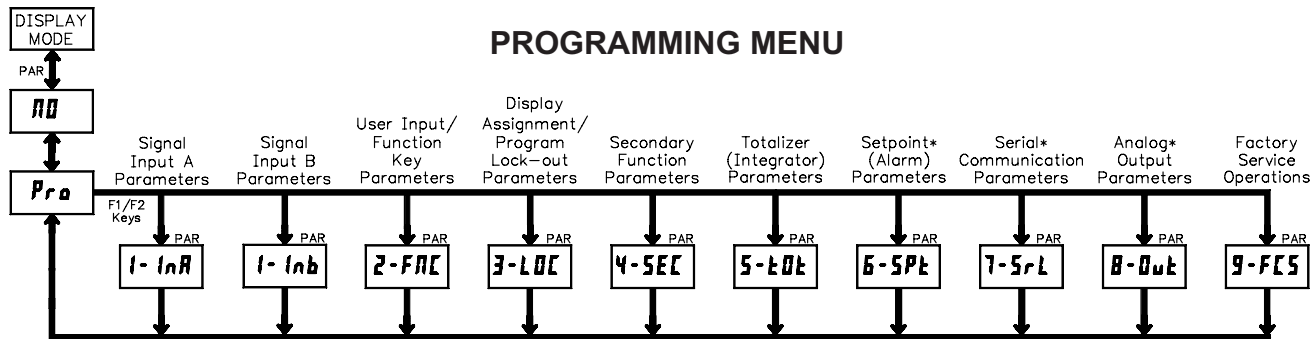

* Only accessible with appropriate plug-in card.

DISPLAY MODE

The meter normally operates in the Display Mode. In this mode, the meter displays can be viewed consecutively by pressing the **DSP** key. The annunciators to the left of the display indicate which display is currently shown; A, B, or C. Each of these displays is programmable and can be locked from view through programming. (See Module 3.)

PROGRAMMING MODE

Two programming modes are available.

Full Programming Mode permits all parameters to be viewed and modified.

Upon entering this mode, the front panel keys change to Programming Mode operations. This mode should not be entered while a process is running, since the meter functions and User Input response may not operate properly while in Full Programming Mode.

Quick Programming Mode permits only certain parameters to be viewed and/or modified. When viewing parameters (SP1, etc), the front panel keys change to Programming Mode operations, and all meter functions continue to operate properly. Quick Programming Mode is configured in Module 3. The Display Intensity Level "d-LEW" parameter is available in the Quick Programming Mode only when the security code is non-zero. For a description, see Module 9—Factory Service Operations. Throughout this document, Programming Mode (without Quick in front) always refers to "Full" Programming Mode.

PROGRAMMING TIPS

The Programming Menu is organized into ten modules (see above). These modules group together parameters that are related in function. It is recommended to begin programming with Module 1 and proceed through each module in sequence. Note that Modules 6 through 8 are only accessible when the appropriate plug-in option card is installed. If lost or confused while programming, press the **DSP** key to exit programming mode and start over. When programming is complete, it is recommended to record the meter settings on the Parameter Value Chart and lock-out parameter programming with a User Input or lock-out code. (See Modules 2 and 3 for lock-out details.)

FACTORY SETTINGS

Factory Settings may be completely restored in Module 9. This is a good starting point if encountering programming problems. Throughout the module description sections which follow, the factory setting for each parameter is shown below the parameter display. In addition, all factory settings are listed on the Parameter Value Chart following the programming section.

ALTERNATING SELECTION DISPLAY

In the module description sections which follow, the dual display with arrows appears for each programming parameter. This is used to illustrate the display alternating between the parameter (top display) and the parameter's Factory Setting (bottom display). In most cases, selections or value ranges for the parameter will be listed on the right.

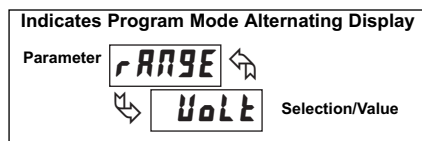

STEP BY STEP PROGRAMMING INSTRUCTIONS:

PROGRAMMING MODE ENTRY (PAR KEY)

The Programming Mode is entered by pressing the **PAR** key. If this mode is not accessible, then meter programming is locked by either a security code or a hardware lock. (See Modules 2 and 3 for programming lock-out details.)

MODULE ENTRY (ARROW & PAR KEYS)

Upon entering the Programming Mode, the display alternates between **Pr0** and the present module (initially **n0**). The arrow keys (**F1▲** and **F2▼**) are used to select the desired module, which is then entered by pressing the **PAR** key.

PARAMETER (MODULE) MENU (PAR KEY)

Each module has a separate parameter menu. These menus are shown at the start of each module description section which follows. The **PAR** key is pressed to advance to a particular parameter to be changed, without changing the programming of preceding parameters. After completing a module, the display will return to **Pr0 n0**. From this point, programming may continue by selecting and entering additional modules. (See **MODULE ENTRY** above.)

PARAMETER SELECTION ENTRY (ARROW & PAR KEYS)

For each parameter, the display alternates between the parameter and the present selection or value for that parameter. For parameters which have a list of selections, the arrow keys (**F1▲** and **F2▼**) are used to sequence through the list until the desired selection is displayed. Pressing the **PAR** key stores and activates the displayed selection, and also advances the meter to the next parameter.

NUMERICAL VALUE ENTRY (ARROW, RST & PAR KEYS)

For parameters which require a numerical value entry, the arrow keys can be used to increment or decrement the display to the desired value. When an arrow key is pressed and held, the display automatically scrolls up or scrolls down. The longer the key is held, the faster the display scrolls.

The **RST** key can be used in combination with the arrow keys to enter large numerical values. When the **RST** key is pressed along with an arrow key, the display scrolls by 1000's. Pressing the **PAR** key stores and activates the displayed value, and also advances the meter to the next parameter.

PROGRAMMING MODE EXIT (DSP KEY or PAR KEY at Pr0 n0)

The Programming Mode is exited by pressing the **DSP** key (from anywhere in the Programming Mode) or the **PAR** key (with **Pr0 n0** displayed). This will commit any stored parameter changes to memory and return the meter to the Display Mode. If a parameter was just changed, the **PAR** key should be pressed to store the change before pressing the **DSP** key. (If power loss occurs before returning to the Display Mode, verify recent parameter changes.)

5.1 MODULE 1 - SIGNAL INPUT PARAMETERS

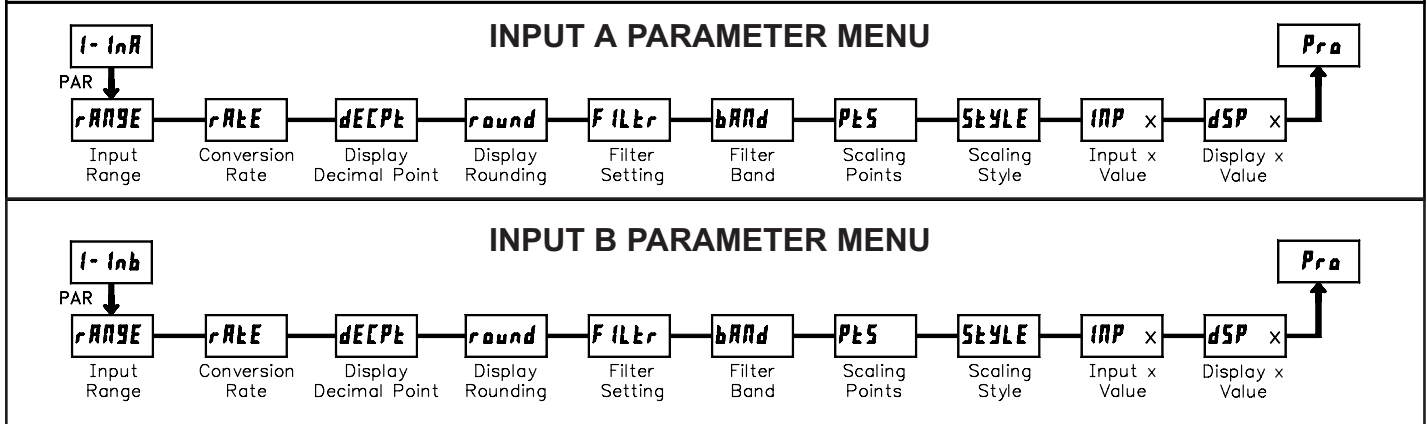

INPUT RANGE

SELECTION	RANGE	RESOLUTION
VolT	10.000 V	
curr	20.000 mA	
U-59r	±10.000 V - Square Root Extraction	
I-59r	±20.000 mA - Square Root Extraction	

Select the input range that corresponds to the external signal. Before applying signal configure input jumper to match setting desired.

ADC CONVERSION RATE

SELECTION	5.3	7.5	16.7	19.8
19.8	20	30	105	

Select the ADC conversion rate. The selection does not affect the display update rate, (however it does affect setpoint response time). The default factory setting of 19.8 is recommended for most applications. Selecting a fast update rate may cause the display to appear very unstable.

DISPLAY DECIMAL POINT

SELECTION	0	00	000	0000	00000
0000					

Select the decimal point location for the Input display. (The **TOT** display decimal point is a separate parameter.) This selection also affects **round**, **dSP1** and **dSP2** parameters and setpoint values.

DISPLAY ROUNDING*

SELECTION	1	2	5	10
0001	20	50	100	

Rounding selections other than one, cause the Input Display to 'round' to the nearest rounding increment selected (ie. rounding of '5' causes 121 to round to 120 and 124 to round to 125). Rounding starts at the least significant digit of the Input Display. Remaining parameter entries (scaling point values, setpoint values, etc.) are not automatically adjusted to this display rounding selection.

FILTER SETTING

SELECTION	00 to 250 seconds
10	

The input filter setting is a time constant expressed in tenths of a second. The filter settles to 99% of the final display value within approximately 3 time constants. This is an Adaptive Digital Filter which is designed to steady the Input Display reading. A value of '0' disables filtering.

FILTER BAND*

SELECTION	0 to 250 display units
0010	

The digital filter will adapt to variations in the input signal. When the variation exceeds the input filter band value, the digital filter disengages. When the variation becomes less than the band value, the filter engages again. This allows for a stable readout, but permits the display to settle rapidly after a large process change. The value of the band is in display units, independent of the Display Decimal Point position. A band setting of '0' keeps the digital filter permanently engaged.

SCALING POINTS

SELECTION	2 to 16
2	

Linear - Scaling Points (2)

For linear processes, only 2 scaling points are necessary. It is recommended that the 2 scaling points be at opposite ends of the input signal being applied. The points do not have to be the signal limits. Display scaling will be linear between and continue past the entered points up to the limits of the Input Signal Jumper position. Each scaling point has a coordinate-pair of Input Value (**INP**) and an associated desired Display Value (**dSP**).

Square Root Extraction Input Range - Scaling Points (2)

The PAXDP can apply the square root function directly to the sensor signal by selecting the Square Root Extraction Input Range (**U-59r** or **I-59r**). When configured for Square Root Extraction, piecewise multipoint linearization is not required and only the first 2 scaling points are used. For proper operation the Display 1 (**dSP1**) value must be zero.

Nonlinear - Scaling Points (Greater than 2)

For non-linear processes, up to 16 scaling points may be used to provide a piece-wise linear approximation. (The greater the number of scaling points used, the greater the conformity accuracy.) The Input Display will be linear between scaling points that are sequential in program order. Each scaling point has a coordinate-pair of Input Value (**INP**) and an associated desired Display Value (**dSP**). Data from tables or equations, or empirical data could be used to derive the required number of segments and data values for the coordinate pairs.

In the Crimson 2 (SFCRM2) software, several linearization equations are available. See the Accessories section for more information.

SCALING STYLE

SELECTION	KEY	key-in data
KEY	APLY	apply signal

If Input Values and corresponding Display Values are known, the Key-in (**KEY**) scaling style can be used. This allows scaling without the presence or changing of the input signal. If Input Values have to be derived from the actual input signal source or simulator, the Apply (**APLY**) scaling style must be used.

* The decimal point position is dependent on the selection made in the "Display Decimal Point" parameter.

INPUT VALUE FOR SCALING POINT 1

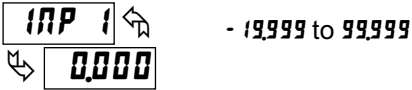

For Key-in (**KEY**), enter the known first Input Value by using the arrow keys. (The Input Range selection sets up the decimal location for the Input Value.) For Apply (**RPLY**), apply the input signal to the meter, adjust the signal source externally until the desired Input Value appears. In either method, press the **PAR** key to enter the value being displayed. The **DSP** key can be pressed without changing the previously stored **INP 1** value in the **RPLY** style.

DISPLAY VALUE FOR SCALING POINT 1*

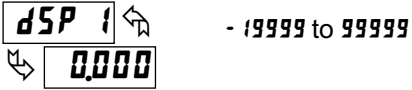

Enter the first coordinating Display Value by using the arrow keys. This is the same for **KEY** and **RPLY** scaling styles. The decimal point follows the **DECPt** selection. For Square Root Extraction Input Range, the Display 1 value must be zero.

INPUT VALUE FOR SCALING POINT 2

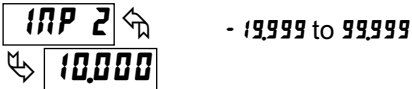

For Key-in (**KEY**), enter the known second Input Value by using the arrow keys. For Apply (**RPLY**), adjust the signal source externally until the next desired Input Value appears. (Follow the same procedure if using more than 2 scaling points.)

* The decimal point position is dependent on the selection made in the "Display Decimal Point" parameter.

DISPLAY VALUE FOR SCALING POINT 2*

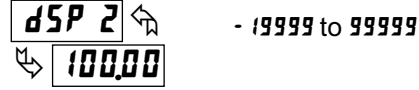

Enter the second coordinating Display Value by using the arrow keys. This is the same for **KEY** and **RPLY** scaling styles. (Follow the same procedure if using more than 2 scaling points.)

General Notes on Scaling

1. Input Values for scaling points should be confined to the limits of the Input Signal, ie. 4-20 mA or 0-10 VDC.
2. The same Input Value should not correspond to more than one Display Value. (Example: 20 mA can not equal 0 and 10.) This is referred to as readout jumps (vertical scaled segments).
3. The same Display Value can correspond to more than one Input Value. (Example: 0 mA and 20 mA can equal 10.) This is referred to as readout dead zones (horizontal scaled segments).
4. The maximum scaled Display Value spread between range maximum and minimum is limited to 65,535. For example using +20 mA range the maximum +20 mA can be scaled to is 32,767 with 0 mA being 0 and Display Rounding of 1. (Decimal points are ignored.) The other half of 65,535 is for the lower half of the range 0 to -20 mA even if it is not used. With Display Rounding of 2, +20 mA can be scaled for 65,535 (32,767 x 2) but with even Input Display values shown.
5. For input levels beyond the first programmed Input Value, the meter extends the Display Value by calculating the slope from the first two coordinate pairs (**INP 1** / **DSP 1** & **INP 2** / **DSP 2**). If **INP 1** = 4 mA and **DSP 1** = 0, then 0 mA would be some negative Display Value. This could be prevented by making **INP 1** = 0 mA / **DSP 1** = 0, **INP 2** = 4 mA / **DSP 2** = 0, with **INP 3** = 20 mA / **DSP 3** = the desired high Display Value. The calculations stop at the limits of the Input Range Jumper position.
6. For input levels beyond the last programmed Input Value, the meter extends the Display Value by calculating the slope from the last two sequential coordinate pairs. If three coordinate pair scaling points were entered, then the Display Value calculation would be between **INP 2** / **DSP 2** & **INP 3** / **DSP 3**. The calculations stop at the limits of the Signal Input.

5.2 MODULE 2 - USER INPUT AND FRONT PANEL FUNCTION KEY PARAMETERS (2-FNC)

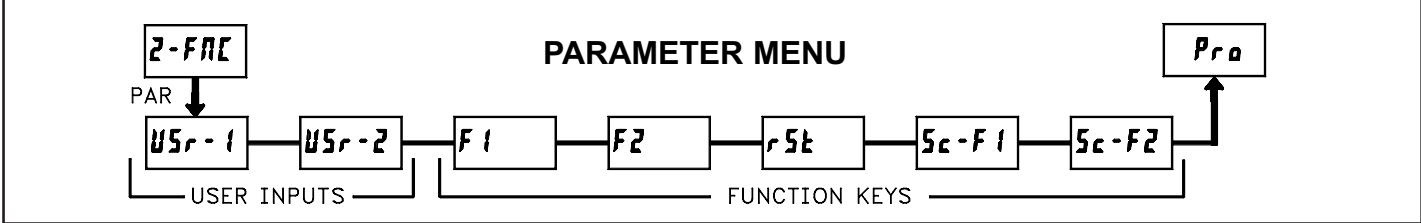

The two user inputs are individually programmable to perform specific meter control functions. While in the Display Mode or Program Mode, the function is executed the instant the user input transitions to the active state.

The front panel function keys are also individually programmable to perform specific meter control functions. While in the Display Mode or when viewing meter values in Quick Programming mode, the primary function is executed the instant the key is pressed. Holding the function key for three seconds executes a secondary function. It is possible to program a secondary function without a primary function.

In most cases, if more than one user input and/or function key is programmed for the same function, the maintained (level trigger) actions will be performed while at least one of those user inputs or function keys are activated. The momentary (edge trigger) actions will be performed every time any of those user inputs or function keys transition to the active state.

Note: In the following explanations, not all selections are available for both user inputs and front panel function keys. Alternating displays are shown with each selection. Those selections showing both displays are available for both. If a display is not shown, it is not available for that selection. **USR-1** will represent both user inputs. **F 1** will represent all five function keys.

NO FUNCTION

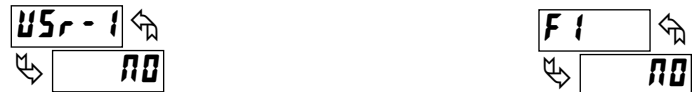

No function is performed if activated. This is the factory setting for all user inputs and function keys. No function can be selected without affecting basic start-up.

PROGRAMMING MODE LOCK-OUT

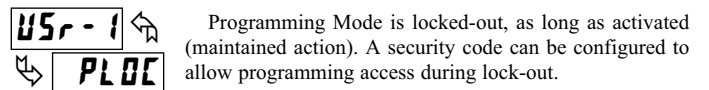

Programming Mode is locked-out, as long as activated (maintained action). A security code can be configured to allow programming access during lock-out.

INPUT A ZERO (TARE) DISPLAY



The Zero (Tare) Display provides a way to zero the Input A value at various input levels, causing future Display readings to be offset. This function is useful in weighing applications where the container or material on the scale should not be included in the next measurement value. When activated (momentary action), **rESEt** flashes and the Input A value is set to zero. At the same time, the Input A value (that was on the display before the Zero Display) is subtracted from the Input A Display Offset Value and is automatically stored as the new Display Offset Value (**DF5-A**). If another Zero (tare) Display is performed, the display will again change to zero and the Input A reading will shift accordingly.

INPUT B ZERO (TARE) DISPLAY



The Zero (Tare) Display provides a way to zero the Input B value at various input levels, causing future Display readings to be offset. This function is useful in weighing applications where the container or material on the scale should not be included in the next measurement value. When activated (momentary action), **rESEt** flashes and the Input B value is set to zero. At the same time, the Input B value (that was on the display before the Zero Display) is subtracted from the Input B Display Offset Value and is automatically stored as the new Display Offset Value (**DF5-b**). If another Zero (tare) Display is performed, the display will again change to zero and the Input B reading will shift accordingly.

INPUT A RELATIVE/ABSOLUTE DISPLAY

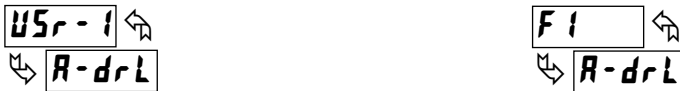

This function will switch the Input A Display between Relative and Absolute. The Relative is a net value that includes the Display Offset Value. The Input A Display will normally show the Relative unless switched by this function. The Absolute is a gross value (based on Module 1 **DSP** and **INP** entries) without the Display Offset Value. The Absolute display is selected as long as the user input is activated (maintained action) or at the transition of the function key (momentary action). When the user input is released, or the function key is pressed again, the input A display switches back to Relative display. **Rb5-A** (absolute) or **rEL-A** (relative) is momentarily displayed at transition to indicate which display is active.

INPUT B RELATIVE/ABSOLUTE DISPLAY



This function will switch the Input B Display between Relative and Absolute. The Relative is a net value that includes the Display Offset Value. The Input B Display will normally show the Relative unless switched by this function. The Absolute is a gross value (based on Module 1 **DSP** and **INP** entries) without the Display Offset Value. The Absolute display is selected as long as the user input is activated (maintained action) or at the transition of the function key (momentary action). When the user input is released, or the function key is pressed again, the input B display switches back to Relative display. **Rb5-B** (absolute) or **rEL-B** (relative) is momentarily displayed at transition to indicate which display is active.

HOLD DISPLAY

The shown display is held but all other meter functions continue as long as activated (maintained action).

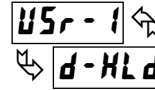

HOLD ALL FUNCTIONS

The meter disables processing the input, holds all display contents, and locks the state of all outputs as long as activated (maintained action). The serial port continues data transfer.

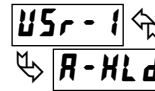

SYNCHRONIZE METER READING

The meter suspends all functions as long as activated (maintained action). When the user input is released, the meter synchronizes the restart of the A/D's with other processes or timing events.

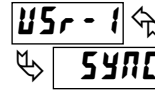

Input assignment for the totalizer is programmed in Module 5, Totalizer (Integrator) Parameters. Only the assigned input or calculation will be active for the following Totalizer User Functions.

STORE BATCH READING IN TOTALIZER



The assigned value is one time added (batched) to the Totalizer at transition to activate (momentary action). The Totalizer retains a running sum of each batch operation until the Totalizer is reset. When this function is selected, the normal operation of the Totalizer is overridden.

RESET TOTALIZER

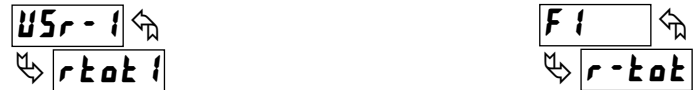

When activated (momentary action), **rESEt** flashes and the Totalizer resets to zero. The Totalizer then continues to operate as it is configured. This selection functions independent of the selected display.

RESET AND ENABLE TOTALIZER

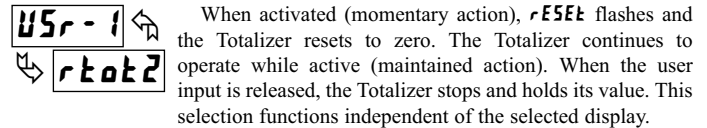

When activated (momentary action), **rESEt** flashes and the Totalizer resets to zero. The Totalizer continues to operate while active (maintained action). When the user input is released, the Totalizer stops and holds its value. This selection functions independent of the selected display.

ENABLE TOTALIZER

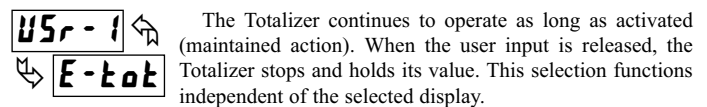

The Totalizer continues to operate as long as activated (maintained action). When the user input is released, the Totalizer stops and holds its value. This selection functions independent of the selected display.

RESET MAXIMUM



When activated (momentary action), **rESEt** flashes and the Maximum resets to the present assigned value. The Maximum function then continues from that value. This selection functions independent of the selected display.

RESET MINIMUM

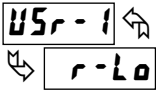

When activated (momentary action), **rESEt** flashes and the Minimum reading is set to the present assigned value. The Minimum function then continues from that value. This selection functions independent of the selected display.

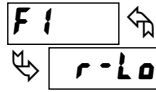

CHANGE DISPLAY INTENSITY LEVEL

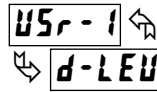

When activated (momentary action), the display intensity changes to the next intensity level (of 4). The four levels correspond to Display Intensity Level (**d-LEU**) settings of 0, 3, 8, and 15.

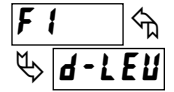

RESET MAXIMUM AND MINIMUM

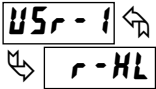

When activated (momentary action), **rESEt** flashes and the Maximum and Minimum readings are set to the present assigned values. The Maximum and Minimum function then continues from that value. This selection functions independent of the selected display.



SETPOINT SELECTIONS

The following selections are functional only with the Setpoint plug-in card installed. Refer to the Setpoint Card Bulletin shipped with the Setpoint plug-in card for an explanation of their operation.

Setpoint Card Only

- L 15t** - Select main or alternate setpoints
- r-1** - Reset Setpoint 1 (Alarm 1)
- r-2** - Reset Setpoint 2 (Alarm 2)
- r-3** - Reset Setpoint 3 (Alarm 3)
- r-4** - Reset Setpoint 4 (Alarm 4)
- r-34** - Reset Setpoint 3 & 4 (Alarm 3 & 4)
- r-234** - Reset Setpoint 2, 3 & 4 (Alarm 2, 3 & 4)
- r-ALL** - Reset Setpoint All (Alarm All)

Note: Following display functions are only available on User Input.

ADVANCE DISPLAY

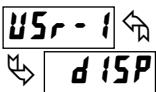

When activated (momentary action), the display advances to the next display that is not locked out from the Display Mode.

SELECT DISPLAY A

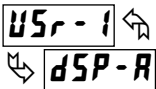

When activated (momentary action), the display advances to Display A, if enabled.

SELECT DISPLAY B

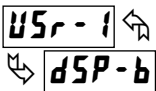

When activated (momentary action), the display advances to Display B, if enabled.

SELECT DISPLAY C

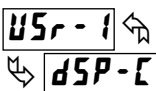

When activated (momentary action), the display advances to Display C, if enabled.

SELECT DISPLAY _

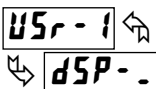

When activated (momentary action), the display advances to the Display _ (no annunciator), if enabled.

SELECT SETPOINT LIST

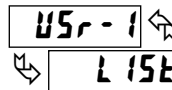

Two lists of values are available for **SP-1**, **SP-2**, **SP-3**, **SP-4**. The two lists are named **L 5t-a** and **L 5t-b**. If a user input is used to select the list then **L 5t-a** is selected when the user input is not active and **L 5t-b** is selected when the user input is active (maintained action). If a front panel key is used to select the list then the list will toggle for each key press (momentary action). The display will only indicate which list is active when the list is changed.

To program the values for **L 5t-a** and **L 5t-b**, first complete the programming of all the parameters. Exit programming and switch to the other list. Re-enter programming and enter the values for **SP-1**, **SP-2**, **SP-3**, **SP-4**. If any other parameters are changed then the other list values must be reprogrammed.

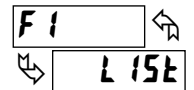

PRINT REQUEST

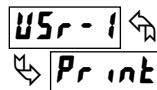

The meter issues a block print through the serial port when activated, and the serial type is set to **rLE**. The data transmitted during a print request and the serial type is programmed in Module 7. If the user input is still active after the transmission is complete (about 100 msec), an additional transmission occurs. As long as the user input is held active, continuous transmissions occur.

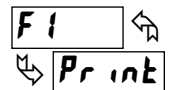

5.3 MODULE 3 - DISPLAY ASSIGNMENT AND PROGRAM LOCK-OUT PARAMETERS (3-LOC)

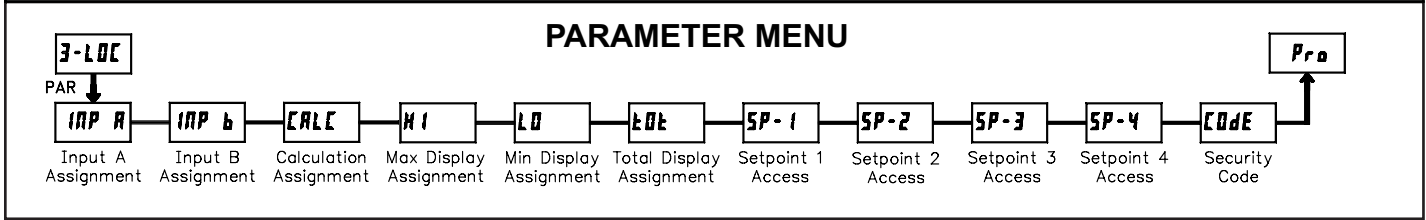

Module 3 is the programming for the Display, Display assignments, Display lock-out and “Full” and “Quick” Program lock-out.

When in the main Display Mode, the available displays (A,B,C,_) can be read consecutively by repeatedly pressing the **DSP** key. An annunciator indicates the display being shown (_ = No annunciator). A meter display value can be programmed to one of the displays, to the quick programming mode or be locked from being visible. It is recommended that the meter display value be set to **LOC** when it is not being used in the application.

“Full” Programming Mode permits all parameters to be viewed and modified. This Programming Mode can be locked with a security code and/or user input. When locked and the PAR key is pressed, the meter enters a Quick Programming Mode. In this mode, the setpoint values can still be read and/or changed per the selections below. The display Intensity Level (**d-LEU**) parameter also appears whenever Quick Programming Mode is enabled and the security code greater than zero.

SP-1 SP-2 SP-3 SP-4 SETPOINT ACCESS*

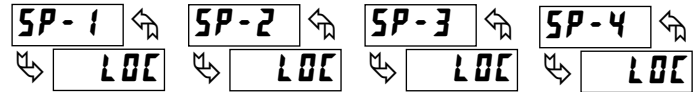

The setpoint displays can be programmed for **LOC**, **rEd** or **ENt** (see the following table). Accessible only with the Setpoint plug-in card installed.

SELECTION	DESCRIPTION
LOC	Not visible in Quick Programming Mode Only
rEd	Visible in Quick Programming Mode Only
ENt	Visible and changeable in Quick Programming Mode Only

DISPLAY ASSIGNMENT

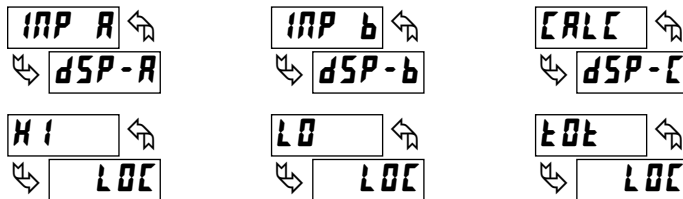

There are six meter values that can be individually programmed for one of the main displays (A,B,C or _), or programmed to be viewable in Quick Programming mode (rEd), or programmed to be locked out from display (LOC) (see the following table). If two or more values are assigned to the same display the last value assigned will be the one that is displayed.

LOC	Not visible in Display Mode or Quick Programming Mode
rEd	Visible in Quick Programming Mode only
dSP- _	Assign to Display _ (No annunciator)
dSP-A	Assign to Display A
dSP-b	Assign to Display B
dSP-C	Assign to Display C

PROGRAM MODE SECURITY CODE*

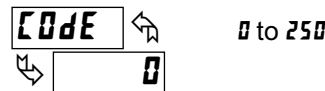

By entering any non-zero value, the prompt **CODE 0** will appear when trying to access the Program Mode. Access will only be allowed after entering a matching security code or universal code of **222**. With this lock-out, a user input would not have to be configured for Program Lock-out. However, this lock-out is overridden by an inactive user input configured for Program Lock-out.

* *Factory Setting can be used without affecting basic start-up.*

PROGRAMMING MODE ACCESS

SECURITY CODE	USER INPUT CONFIGURED	USER INPUT STATE	WHEN PAR KEY IS PRESSED	“FULL” PROGRAMMING MODE ACCESS
0	not PLDC	_____	“Full” Programming	Immediate access.
>0	not PLDC	_____	Quick Programming w/Display Intensity	After Quick Programming with correct code # at CODE prompt.
>0	PLDC	Active	Quick Programming w/Display Intensity	After Quick Programming with correct code # at CODE prompt.
>0	PLDC	Not Active	“Full” Programming	Immediate access.
0	PLDC	Active	Quick Programming	No access
0	PLDC	Not Active	“Full” Programming	Immediate access.

Throughout this document, Programming Mode (without Quick in front) always refers to “Full” Programming (all meter parameters are accessible).

5.4 MODULE 4 - SECONDARY FUNCTION PARAMETERS (4-5EE)

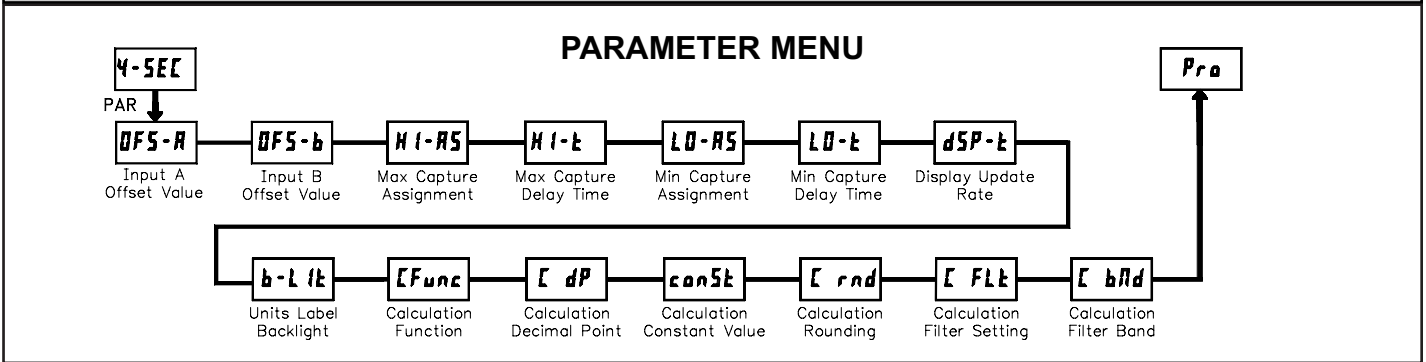

INPUT A OFFSET VALUE*

OFS-A ←
← **0.000**

- 19999 to 19999

Unless a Zero Display was performed or an offset from Module 1 scaling is desired for Input A, this parameter can be skipped. The Display Offset Value is the difference between the Absolute (gross) Display value and the Relative (net) Display value for the same input level. The meter will automatically update this Display Offset Value after each Zero Display. The Display Offset Value can be directly keyed-in to intentionally add or remove display offset. See Relative / Absolute Display and Zero Display explanations in Module 2.

INPUT B OFFSET VALUE*

OFS-b ←
← **0.000**

- 19999 to 19999

Unless a Zero Display was performed or an offset from Module 1 scaling is desired for Input B, this parameter can be skipped. The Display Offset Value is the difference between the Absolute (gross) Display value and the Relative (net) Display value for the same input level. The meter will automatically update this Display Offset Value after each Zero Display. The Display Offset Value can be directly keyed-in to intentionally add or remove display offset. See Relative / Absolute Display and Zero Display explanations in Module 2.

MAX CAPTURE ASSIGNMENT

HI-RS ←
← **A-rEL**

A-rEL A-RbS b-rEL b-RbS CALC

Select the desired parameter that will be assigned to the Max Capture.

MAX CAPTURE DELAY TIME

HI-t ←
← **10**

00 to 32750 sec.

When the Input Display is above the present MAX value for the entered delay time, the meter will capture that display value as the new MAX reading. A delay time helps to avoid false captures of sudden short spikes.

MIN CAPTURE ASSIGNMENT

LO-RS ←
← **A-rEL**

A-rEL A-RbS b-rEL b-RbS CALC

Select the desired parameter that will be assigned to the Min Capture.

MIN CAPTURE DELAY TIME

LO-t ←
← **10**

00 to 32750 sec.

When the Input Display is below the present MIN value for the entered delay time, the meter will capture that display value as the new MIN reading. A delay time helps to avoid false captures of sudden short spikes.

DISPLAY UPDATE RATE

dSP-t ←
← **1**

1 2 5 10 20 updates/sec.

This parameter determines the rate of display update.

UNITS LABEL BACKLIGHT

b-L It ←
← **OFF**

ON OFF

The Units Label Kit Accessory contains a sheet of custom unit overlays which can be installed in to the meter's bezel display assembly. The backlight for these custom units is activated by this parameter.

CALCULATION FUNCTION

CFunc ←
← **cAAb**

cAAb c-A-b cA-b Ab/c cAb c(Ab-t)

This parameter determines the math calculation that will be performed on Input A and Input B and shown on the calculation display. The above formulas represent the available calculations; **A** = Input A relative value, **b** = Input B relative value, and **c** = Calculation Constant Value (**conSt**). The Input A & B decimal point locations do not affect the math function.

CALCULATION DECIMAL POINT

c dP ←
← **0.000**

0 00 000 0000 00000

This parameter determines the decimal point location for the Calculation Display.

* The decimal point position is dependent on the selection made in the "Display Decimal Point" parameter.

CALCULATION CONSTANT VALUE



The constant value is used in the Calculation Function formulas to provide offsetting or scaling capabilities. For the C+A+b, C-A-b, and C+A-b calculation functions, the Constant decimal point matches that Calculation Decimal point position.

CALCULATION FILTER SETTING



The calculation filter setting is a time constant expressed in tenths of a second. The filter settles to 99% of the final display value within approximately 3 time constants. This is an Adaptive Digital Filter which is designed to steady the Calculation Display reading. A value of '0' disables filtering.

CALCULATION ROUNDING*

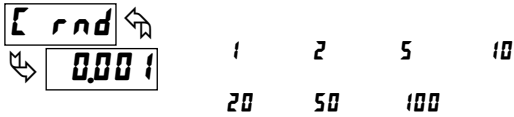

Rounding selections other than one, cause the Calculation Display to 'round' to the nearest rounding increment selected (ie. rounding of '0.005' causes 0.121 to round to 0.120 and 0.124 to round to 125). Rounding starts at the least significant digit of the Calculation Display. Remaining parameter entries (scaling point values, setpoint values, etc.) are not automatically adjusted to this display rounding selection. The displayed decimal point reflects that programmed in **dP**.

CALCULATION FILTER BAND*

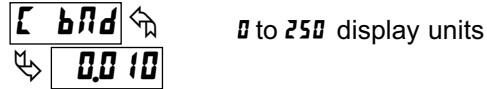

The digital filter will adapt to variations in the calculation filter. When the variation exceeds the calculation filter band value, the digital filter disengages. When the variation becomes less than the band value, the filter engages again. This allows for a stable readout, but permits the display to settle rapidly after a large process change. The value of the band is in display units, independent of the Display Decimal Point position. A band setting of '0' keeps the digital filter permanently engaged.

* The decimal point position is dependent on the selection made in the "Calculation Decimal Point" parameter.

5.5 MODULE 5 - TOTALIZER (INTEGRATOR) PARAMETERS (5-tot)

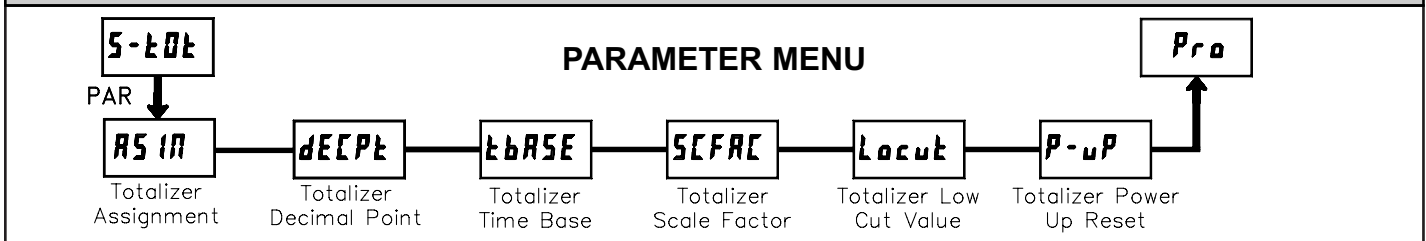

The totalizer accumulates (integrates) the relative Input value using one of two modes. The first is using a time base. This can be used to provide an indication of total flow, usage or consumption over time. The second is through a user input or function key programmed for Batch (one time add on demand). This can be used for weighing applications where accumulation is based on a completed event. If the Totalizer is not needed, its display can be locked-out and this module can be skipped during programming.

TOTALIZER TIME BASE

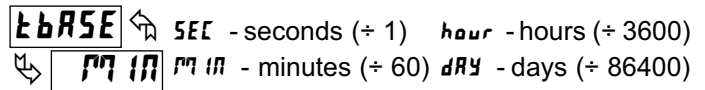

This is the time base used in Totalizer accumulations. If the Totalizer is being accumulated through a user input programmed for Batch, then this parameter does not apply.

TOTALIZER ASSIGNMENT



This parameter determines which value is to be totalized.

TOTALIZER SCALE FACTOR*



For most applications, the Totalizer reflects the same decimal point location and engineering units as the assigned Input Display. In these cases, the Totalizer Scale Factor is 1.000. The Totalizer Scale Factor can be used to scale the Totalizer to a different value than the Input Display. Common possibilities are:

1. Changing decimal point location (example tenths to whole)
2. Average over a controlled time frame.

Details on calculating the scale factor are shown later.

If the Totalizer is being accumulated through a user input programmed for Batch, then this parameter does not apply.

TOTALIZER DECIMAL POINT*



For most applications, this should match the decimal point position of the meter value selected in the totalizer assignment. If a different location is desired, refer to Totalizer Scale Factor.

TOTALIZER LOW CUT VALUE*

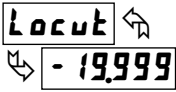

- 19999 to 99999

A low cut value disables Totalizer when the Input Display value falls below the value programmed.

TOTALIZER POWER UP RESET

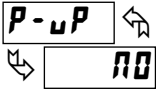

NO Do not reset totalizer
YES Reset totalizer

The Totalizer can be reset to zero on each meter power-up by setting this parameter to reset.

* The decimal point position is dependent on the selection made in the "Totalizer Decimal Point" parameter.

TOTALIZER HIGH ORDER DISPLAY

When the total exceeds 5 digits, the front panel annunciator flashes (if assigned to A, B, or C display). In this case, the meter continues to totalize up to a 9 digit value. The high order 4 digits and the low order 5 digits of the total are displayed alternately. The letter "h" denotes the high order display.

TOTALIZER BATCHING

The Totalizer Time Base and scale factor are overridden when a user input or function key is programmed for store batch (bRt). In this mode, when the user input or function key is activated, the Input Display reading is one time added to the Totalizer (batch). The Totalizer retains a running sum of each batch operation until the Totalizer is reset. This is useful in weighing operations, when the value to be added is not based on time but after a filling event.

TOTALIZER USING TIME BASE

Totalizer accumulates as defined by:

$$\frac{\text{Input Display} \times \text{Totalizer Scale Factor}}{\text{Totalizer Time Base}}$$

Where:

- Input Display - the present input reading
- Totalizer Scale Factor - 0.001 to 65.000
- Totalizer Time Base - (the division factor of tBRSE)

Example: The input reading is at a constant rate of 10.0 gallons per minute. The Totalizer is used to determine how many gallons in tenths has flowed. Because the Input Display and Totalizer are both in tenths of gallons, the Totalizer Scale Factor is 1. With gallons per minute, the Totalizer Time Base is minutes (60). By placing these values in the equation, the Totalizer will accumulate every second as follows:

$$\frac{10.0 \times 1.000}{60} = 0.1667 \text{ gallons accumulate each second}$$

- This results in:
- 10.0 gallons accumulate each minute
- 600.0 gallons accumulate each hour

TOTALIZER SCALE FACTOR CALCULATION EXAMPLES

1. When changing the Totalizer Decimal Point (dECPt) location from the Input Display Decimal Point (dECPt), the required Totalizer Scale Factor is multiplied by a power of ten.

Example: Input (dECPt) = 0.0 Input (dECPt) = 0.00

Totalizer dECPt	Scale Factor
0.00	10
0.0	1
0	.1
x10	.01
x100	.001

Totalizer dECPt	Scale Factor
0.000	10
0.00	1
0.0	.1
0	.01
x10	.001

(x = Totalizer display is round by tens or hundreds)

2. To obtain an average reading within a controlled time frame, the selected Totalizer Time Base is divided by the given time period expressed in the same timing units.

Example: Average flow rate per hour in a 4 hour period, the scale factor would be 0.250. To achieve a controlled time frame, connect an external timer to a user input programmed for rktZ. The timer will control the start (reset) and the stopping (hold) of the totalizer.

Modules 6, 7, and 8 are accessible only with the appropriate plug-in cards installed. A quick overview of Modules 6 & 8 is listed below. Refer to the corresponding plug-in card bulletin for a more detailed explanation of each parameter selection.

5.6 MODULE 6 - SETPOINT (ALARM) PARAMETERS (6-SPt)

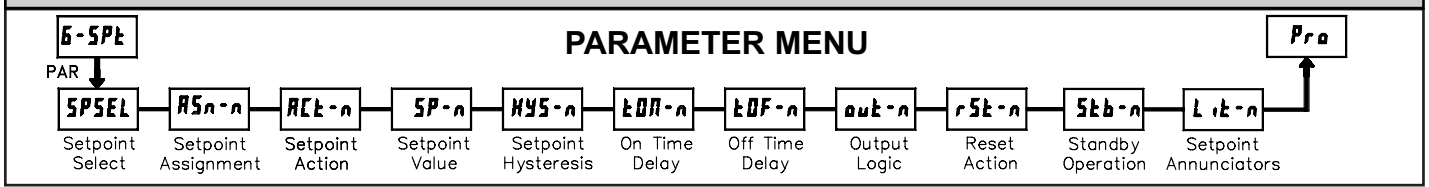

Repeat programming for each setpoint.

SELECT SETPOINT



Select a setpoint (alarm output) to open the remaining module menu. (The "n" in the following parameters will reflect the chosen setpoint number.) After the chosen setpoint is programmed, the display will default to **SPSEL NO**. Select the next setpoint to be programmed and continue the sequence for each setpoint. Pressing **PAR** at **SPSEL NO** will exit Module 6.

The parameters listed below are different from those listed in the Setpoint Card Literature. Use the Refer to Setpoint Option Card Literature for all other setpoint parameters.

SP-n - SETPOINT VALUE	-19999 to 99999
HYS-n - SETPOINT HYSTERESIS	1 to 65000
TON-n - ON TIME DELAY	00 to 32750 sec
TOF-n - OFF TIME DELAY	00 to 32750 sec
OUT-n - OUTPUT LOGIC	nor rEu
RST-n - RESET ACTION	RUto LRAE2 LRAE1
STB-n - STANDBY OPERATION	NO YES
LIT-n - SETPOINT ANNUNCIATORS	OFF rEu nor FLASH

SETPOINT ASSIGNMENT

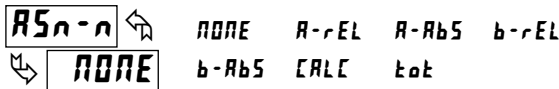

Selects the meter value that is used to trigger the Setpoint Alarm. The -rEL settings cause the setpoint to trigger off of the relative (net) input value. The -AbS settings cause the setpoint to trigger off of the absolute (gross) input value.

SETPOINT ACTION

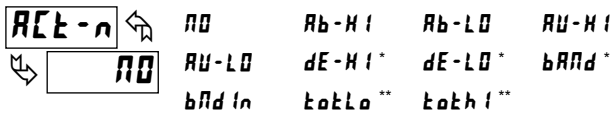

Enter the action for the selected setpoint (alarm output).

See Setpoint Alarm Figures in the Setpoint Card Literature for a visual detail of each action.

- NO** = No Setpoint Action
- Ab-HI** = Absolute high, with balanced hysteresis
- Ab-LO** = Absolute low, with balanced hysteresis
- RU-HI** = Absolute high, with unbalanced hysteresis
- RU-LO** = Absolute low, with unbalanced hysteresis
- dE-HI** = Deviation high, with unbalanced hysteresis *
- dE-LO** = Deviation low, with unbalanced hysteresis *
- bAND** = Outside band, with unbalanced hysteresis *
- bANDin** = Inside band, with unbalanced hysteresis *
- totLo** = Lower Totalizer absolute high, unbalance hysteresis **
- totHi** = Upper Totalizer absolute high, unbalance hysteresis **

* Setpoint 2 or Setpoint 4 deviation and band action setpoints are relative to the value of setpoint 1 or Setpoint 3 respectively. It is not possible to configure setpoint 1 or 3 as deviation or band actions. It is possible to use setpoint 1 or 3 for an absolute action, while its value is being used for deviation or band.

** These modes only appear, and are the only modes that appear, when the setpoint assignment **ASn-n** is set to **tot**. The lower Totalizer action, **totLo**, allows setpoints to function off of the lower 5 digits of the Totalizer. The upper Totalizer action, **totHi**, allows setpoints to function off of the upper 4 digits of the Totalizer. To obtain absolute low alarms for the Totalizer, program the **totLo** or **totHi** output logic as reverse.

5.7 MODULE 7 - SERIAL COMMUNICATIONS PARAMETERS (7-5rL)

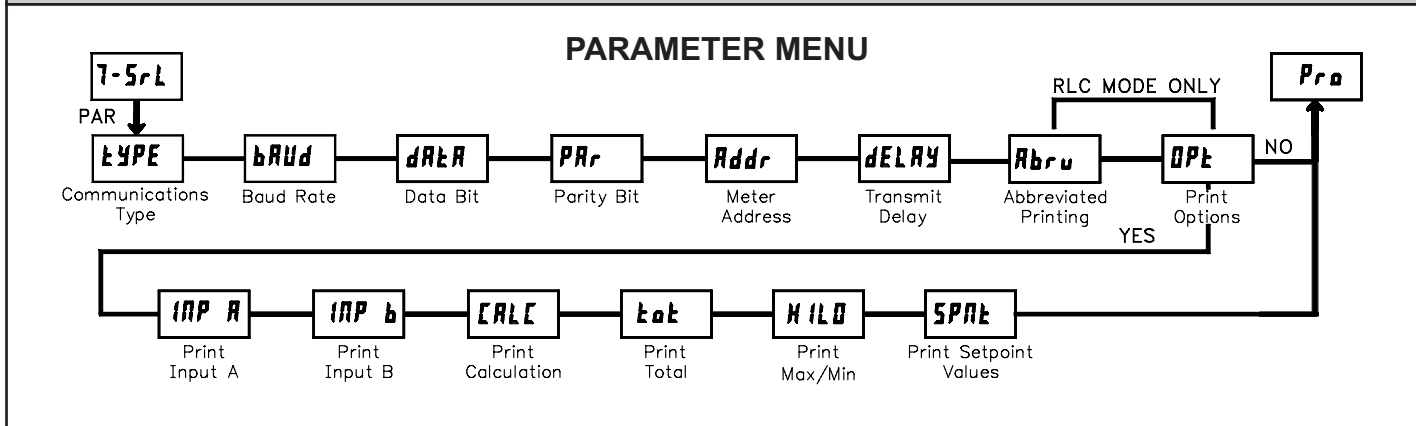

Module 7 is the programming module for the Serial Communications Parameters. These parameters are used to match the serial settings of the PAXDP with those of the host computer or other serial device, such as a terminal or printer. This programming module can only be accessed if an RS232 or RS485 Serial Communications card is installed.

This section also includes an explanation of the commands and formatting required for communicating with the PAXDP. In order to establish serial communications, the user must have host software that can send and receive ASCII characters or utilizes Modbus protocol. For serial hardware and wiring details, refer to section 3.6 Serial Communication Wiring.

This section replaces the bulletin shipped with the RS232 and RS485 serial communications plug-in cards. Discard the separate bulletin when using those serial plug-in cards with the PAXDP. Also, this section does NOT apply to the DeviceNet, or Profibus-DP communication cards. For details on the operation of the Fieldbus cards, refer to the bulletin shipped with each card.

COMMUNICATIONS TYPE



- rLC - RLC Protocol
- MODBUS - Modbus RTU
- MODBUS - Modbus ASCII

Select the desired communications protocol. Modbus is preferred as it provides access to all meter values and parameters. Since the Modbus protocol is included within the PAXDP, the PAX Modbus option card, PAXCDC4, should not be used. The PAXCDC1 (RS485), or PAXCDC2 (RS232) card should be used instead.

BAUD RATE

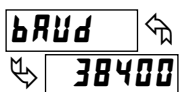

- | | | | |
|------|------|-------|-------|
| 300 | 600 | 1200 | 2400 |
| 4800 | 9600 | 19200 | 38400 |

Set the baud rate to match the other serial communications equipment on the serial link. Normally, the baud rate is set to the highest value that all the serial equipment are capable of transmitting and receiving.

DATA BIT

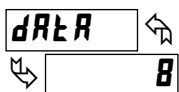

- 7
- 8

Select either 7 or 8 bit data word lengths. Set the word length to match the other serial communications equipment on the serial link.

PARITY BIT

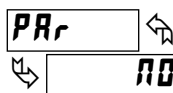

- NO
- EVEN
- ODD

Set the parity bit to match that of the other serial communications equipment on the serial link. The meter ignores the parity when receiving data and sets the parity bit for outgoing data. If no parity is selected with 7 bit word length, an additional stop bit is used to force the frame size to 10 bits.

METER UNIT ADDRESS

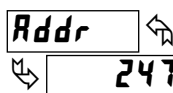

- 00 to 99 (RLC Protocol)
- 1 to 247 (Modbus)

Enter the serial meter (node) address. The address range is dependent on the TYPE parameter. With a single unit, configured for RLC protocol (TYPE = rLC), an address is not needed and a value of zero can be used. With multiple units (RS485 applications), a unique 2 digit address number must be assigned to each meter.

TRANSMIT DELAY



- 0.010 to 0.250

Following a transmit value (** terminator) or Modbus command, the PAXDP will wait this minimum amount of time in seconds before issuing a serial response.

Parameters below only appear when communications type (*TYPE*) parameter is set to *RLC*.

ABBREVIATED PRINTING



Select *NO* for full print or Command T transmissions (meter address, parameter data and mnemonics) or *YES* for abbreviated print transmissions (parameter data only). This will affect all the parameters selected in the print options. (If the meter address is 00, it will not be sent during a full transmission.)

PRINT OPTIONS



YES - Enters the sub-menu to select the meter parameters to appear during a print request. For each parameter in the sub-menu, select *YES* for that parameter information to be sent during a print request or *NO* for that parameter information not to be sent. A print request is sometimes referred to as a block print because more than one parameter information (meter address, parameter data and mnemonics) can be sent to a printer or computer as a block.

PARAMETER	DESCRIPTION
<i>INP a</i>	Input A Value
<i>INP b</i>	Input B Value
<i>CRLC</i>	Calculation
<i>tot</i>	Total Value
<i>HLB</i>	Max. & Min.
<i>SPnt</i>	Setpoint Values

SERIAL MODBUS COMMUNICATIONS

Modbus Communications requires that the Serial Communication Type Parameter (*TYPE*) be set to "*Modbus*" or "*Modbus*".

SUPPORTED FUNCTION CODES

FC03: Read Holding Registers

- Up to 32 registers can be requested at one time.
- HEX <8000> is returned for non-used registers.

FC04: Read Input Registers

- Up to 32 registers can be requested at one time.
- Block starting point can not exceed register boundaries.
- HEX <8000> is returned in registers beyond the boundaries.
- Input registers are a mirror of Holding registers.

FC06: Preset Single Register

- HEX <8001> is echoed back when attempting to write to a read only register.
- If the write value exceeds the register limit (see Register Table), then that register value changes to its high or low limit. It is also returned in the response.

FC16: Preset Multiple Registers

- No response is given with an attempt to write to more than 32 registers at a time.
- Block starting point cannot exceed the read and write boundaries (40001-41280).
- If a multiple write includes read only registers, then only the write registers will change.
- If the write value exceeds the register limit (see Register Table), then that register value changes to its high or low limit.

FC08: Diagnostics

The following is sent upon FC08 request:

Module Address, 08 (FC code), 04 (byte count), "Total Comms" 2 byte count, "Total Good Comms" 2 byte count, checksum of the string

"Total Comms" is the total number of messages received that were addressed to the PAXDP. "Total Good Comms" is the total messages received by the PAXDP with good address, parity and checksum. Both counters are reset to 0 upon response to FC08 and at power-up.

FC17: Report Slave ID

The following is sent upon FC17 request:

RLC-PAXDP ab<0100h><20h><20h><10h>

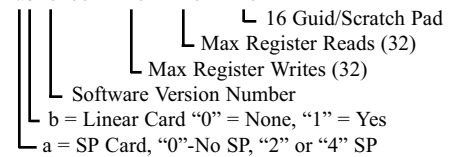

- a = "0"(none), "2", "4" SP card installed
- b = "0"(none) or "1" Linear Card installed,

SUPPORTED EXCEPTION CODES

01: Illegal Function

Issued whenever the requested function is not implemented in the meter.

02: Illegal Data Address

Issued whenever an attempt is made to access a single register that does not exist (outside the implemented space) or to access a block of registers that falls completely outside the implemented space.

03: Illegal Data Value

Issued when an attempt is made to read or write more registers than the meter can handle in one request.

07: Negative Acknowledge

Issued when a write to a register is attempted with an invalid string length.

PAXDP MODBUS REGISTER TABLE

The below limits are shown as Integers or HEX <> values. Read and write functions can be performed in either Integers or Hex as long as the conversion was done correctly. Negative numbers are represented by two's complement.

Note 1: The PAXDP should not be powered down while parameters are being changed. Doing so may corrupt the non-volatile memory resulting in checksum errors.

REGISTER ADDRESS ¹	REGISTER NAME	LOW LIMIT ²	HIGH LIMIT ²	FACTORY SETTING	ACCESS	COMMENTS
FREQUENTLY USED REGISTERS						
40001	Input A Relative Value (Hi word)	N/A	N/A	N/A	Read Only	Process value of present input level. This value is affected by Input Type, Resolution, Scaling & Offset Value (Relative Value = Absolute Input Value + Offset Value)
40002	Input A Relative Value (Lo word)					
40003	Input B Relative Value (Hi word)	N/A	N/A	N/A	Read Only	Process value of present input level. This value is affected by Input Type, Resolution, Scaling & Offset Value (Relative Value = Absolute Input Value + Offset Value)
40004	Input B Relative Value (Lo word)					
40005	Calculation Value (Hi word)	N/A	N/A	N/A	Read Only	Calculation Result of Math Function
40006	Calculation Value (Lo word)					
40007	Maximum Value (Hi word)	N/A	N/A	N/A	Read Only	
40008	Maximum Value (Lo word)					
40009	Minimum Value (Hi word)	N/A	N/A	N/A	Read Only	
40010	Minimum Value (Lo word)					
40011	Total Value (Hi word)	N/A	N/A	N/A	Read Only	
40012	Total Value (Lo word)					
40013	Setpoint 1 Value (Hi word)	-19999	99999	100	Read/Write	
40014	Setpoint 1 Value (Lo word)					
40015	Setpoint 2 Value (Hi word)	-19999	99999	200	Read/Write	
40016	Setpoint 2 Value (Lo word)					
40017	Setpoint 3 Value (Hi word)	-19999	99999	300	Read/Write	
40018	Setpoint 3 Value (Lo word)					
40019	Setpoint 4 Value (Hi word)	-19999	99999	400	Read/Write	
40020	Setpoint 4 Value (Lo word)					
40021	Setpoint Output Register (SOR)	0	15	N/A	Read/Write See Note	Status of Setpoint Outputs: Bit State: 0=Off, 1=On, Bit 3 = SP1, Bit 2 = SP2, Bit 1 = SP3, Bit 0 = SP4 Outputs can only be activated/reset with this register when respective bits in Manual Mode (MMR) register are set
40022	Manual Mode Register (MMR)	0	31	0	Read/Write	Bit State: 0=Auto Mode, 1=Manual Mode Bit 4 = SP1, Bit 3 = SP2, Bit 2 = SP3, Bit 1 = SP4, Bit 0 = Linear Output
40023	Reset Output Register	0	15	0	Read/Write	Bit State: 1= Reset Output; Bit is returned to zero following reset processing Bit 3 = SP1, Bit 2 = SP2, Bit 1 = SP3, Bit 0 = SP4
40024	Analog Output Register (AOR)	0	4095	0	Read/Write	Functional only if Linear Output is in manual mode (MMR bit 0 = 1). Linear Output Card is written to only if Linear Out (MMR bit 0) is set
40025	Input A Absolute Value (Hi word)	N/A	N/A	N/A	Read Only	Gross value of present Input A level. This value is affected by Input Type, Resolution, Scaling, but not affected by Offset Value
40026	Input A Absolute Value (Lo word)					
40027	Input B Absolute Value (Hi word)	N/A	N/A	N/A	Read Only	Gross value of present Input B level. This value is affected by Input Type, Resolution, Scaling, but not affected by Offset Value
40028	Input B Absolute Value (Lo word)					
40029	Input A Offset Value (Hi word)	-19999	99999	0	Read/Write	Relative Input Value (standard meter value) is sum of Input Offset Value and Input Absolute Value
40030	Input A Offset Value (Lo word)					
40031	Input B Offset Value (Hi word)	-19999	99999	0	Read/Write	Relative Input Value (standard meter value) is sum of Input Offset Value and Input Absolute Value
40032	Input B Offset Value (Lo word)					
40033	Main Setpoint 1 Value (Hi word)	-19999	99999	100	Read/Write	Setpoint List A
40034	Main Setpoint 1 Value (Lo word)					
40035	Main Setpoint 2 Value (Hi word)	-19999	99999	200	Read/Write	Setpoint List A
40036	Main Setpoint 2 Value (Lo word)					
40037	Main Setpoint 3 Value (Hi word)	-19999	99999	300	Read/Write	Setpoint List A
40038	Main Setpoint 3 Value (Lo word)					
40039	Main Setpoint 4 Value (Hi word)	-19999	99999	400	Read/Write	Setpoint List A
40040	Main Setpoint 4 Value (Lo word)					
40041	Alternate Setpoint 1 Value (Hi word)	-19999	99999	100	Read/Write	Setpoint List B
40042	Alternate Setpoint 1 Value (Lo word)					

¹ For Input Registers, replace the 4xxx with a 3xxx in the above register address. The 3xxx are a mirror of the 4xxx Holding Registers.

² An attempt to exceed a limit will set the register to its high or low limit value.

REGISTER ADDRESS ¹	REGISTER NAME	LOW LIMIT ²	HIGH LIMIT ²	FACTORY SETTING	ACCESS	COMMENTS	
FREQUENTLY USED REGISTERS (Continued)							
40043	Alternate Setpoint 2 Value (Hi word)	-19999	99999	200	Read/Write	Setpoint List B	
40044	Alternate Setpoint 2 Value (Lo word)						
40045	Alternate Setpoint 3 Value (Hi word)	-19999	99999	300	Read/Write	Setpoint List B	
40046	Alternate Setpoint 3 Value (Lo word)						
40047	Alternate Setpoint 4 Value (Hi word)	-19999	99999	400	Read/Write	Setpoint List B	
40048	Alternate Setpoint 4 Value (Lo word)						
CH A	CH B	INPUT PARAMETERS				SEE MODULE 1 FOR DESCRIPTION OF PARAMETERS	
40101	40201	Input Range	0	1	0	Read/Write	0=Volt, 1=Current, 2=Volt Square Root Extraction, 3= Current Square Root Extraction
40102	40202	ADC Conversion Rate (samples/sec)	0	6	3	Read/Write	0=5.3, 1=7.5, 2=16.7, 3=19.8, 4=20, 5=30, 6=105
40103	40203	Decimal Point	0	4	3	Read/Write	0=0, 1=0.0, 2=0.00, 3=0.000, 4=0.0000
40104	40204	Rounding Factor	0	6	0	Read/Write	0=1, 1=2, 2=5, 3=10, 4=20, 5=50, 6=100
40105	40205	Digital Input Filter	0	250	10	Read/Write	1=0.1 Second
40106	40206	Filter Band	0	250	10	Read/Write	1=1 display unit
40107	40207	Number of Scaling Points	2	16	2	Read/Write	Number of Llinearization Scaling Points
40108	40208	Reserved	N/A	N/A	N/A	N/A	
SCALING POINTS PARAMETERS							
40109	40209	Input 1 Input Value (Hi word)	-19999	99999	0	Read/Write	1=0.001
40110	40210	Input 1 Input Value (Lo word)					
40111	40211	Display 1 Input Value (Hi word)	-19999	99999	0	Read/Write	
40112	40212	Display 1 Input Value (Lo word)					
thru	thru		Registers 40113-40168, 40213-40268 not shown but follow ordering as shown for Input 1, Display 1
40169	40269	Input 16 Input Value (Hi word)	-19999	99999	0	Read/Write	1=0.001
40170	40270	Input 16 Input Value (Lo word)					
40171	40271	Input 16 Input Value (Hi word)	-19999	99999	0	Read/Write	
40172	40272	Input 16 Input Value (Lo word)					
USER INPUT/FUNCTION KEYS							SEE MODULE 2 FOR DESCRIPTIONS OF PARAMETERS
40301	User Input 1 Action	0	30	0	Read/Write	0= NO 8 = SYNC 16 = dISP 24 = r-2 1 = PLOC 9 = bAt 17 = dSP-A 25 = r-3 2 = A-rEL 10 = rto1 18 = dSP-b 26 = r-4 3 = b-rEL 11 = rto2 19 = dSP-C 27 = r-34 4 = A-drL 12 = E-tot 20 = dSP- 28 = r-234 5 = b-drL 13 = r-HI 21 = d-LEV 29 = r-ALL 6 = d-HLd 14 = r-Lo 22 = LISt 30 = Print 7 = A-HLd 15 = r-HL 23 = r-1	
40302	User Input 2 Action	0	30	0	Read/Write	See User Input 1 above	
40303	User F1 Key Action	0	19	0	Read/Write	0 = NO 5 = bAt 10 = d-LEV 15 = r-4 1 = A-rEL 6 = rto 11 = LISt 16 = r-34 2 = b-rEL 7= r-HI 12 = r-1 17 = r-234 3 = A-drL 8 = r-Lo 13 = r-2 18 = r-ALL 4 = b-drL 9 = r-HL 14 = r-3 19 = Print	
40304	User F2 Key Action	0	19	0	Read/Write	See User F1 Key Description	
40305	User Reset Key Action	0	19	0	Read/Write	See User F1 Key Description	
40306	User F1 Second Action	0	19	0	Read/Write	See User F1 Key Description	
40307	User F2 Second Action	0	19	0	Read/Write	See User F1 Key Description	
DISPLAY/QUICK PRO MENU LOCKS							SEE MODULE 3 FOR DESCRIPTIONS OF PARAMETERS
40311	Input A Display Lock	0	5	3	Read/Write	0=Loc, 1=Red, 2=Disp _, 3=Disp A, 4= Disp B, 5=Disp C	
40312	Input B Display	0	5	4	Read/Write	0=Loc, 1=Red, 2=Disp _, 3=Disp A, 4= Disp B, 5=Disp C	
40313	Calculation Display	0	5	5	Read/Write	0=Loc, 1=Red, 2=Disp _, 3=Disp A, 4= Disp B, 5=Disp C	
40314	Maximum (Hi) Value	0	5	0	Read/Write	0=Loc, 1=Red, 2=Disp _, 3=Disp A, 4= Disp B, 5=Disp C	
40315	Minimum (Lo) Value	0	5	0	Read/Write	0=Loc, 1=Red, 2=Disp _, 3=Disp A, 4= Disp B, 5=Disp C	
40316	Total Display	0	5	0	Read/Write	0=Loc, 1=Red, 2=Disp _, 3=Disp A, 4= Disp B, 5=Disp C	
40317	SP1 Quick Pro	0	2	0	Read/Write	0 = Lock, 1=Read, 2=Enter	
40318	SP2 Quick Pro	0	2	0	Read/Write	0 = Lock, 1=Read, 2=Enter	
40319	SP3 Quick Pro	0	2	0	Read/Write	0 = Lock, 1=Read, 2=Enter	
40320	SP4 Quick Pro	0	2	0	Read/Write	0 = Lock, 1=Read, 2=Enter	
40321	Program Mode Security Code	0	250	0	Read/Write		
40322	Display Intensity Level	0	15	3	Read/Write	0 = Min Intensity, 15 = Max Intensity	

¹ For Input Registers, replace the 4xxxx with a 3xxxx in the above register address. The 3xxxx are a mirror of the 4xxxx Holding Registers.

² An attempt to exceed a limit will set the register to its high or low limit value.

REGISTER ADDRESS ¹	REGISTER NAME	LOW LIMIT ²	HIGH LIMIT ²	FACTORY SETTING	ACCESS	COMMENTS
SECONDARY PARAMETERS						SEE MODULE 4 FOR DESCRIPTIONS OF PARAMETERS
40029	Input A Offset Value (Hi word)	-19999	99999	0	Read/Write	*Value shown here for reference
40030	Input A Offset Value (Lo word)					
40031	Input B Offset Value (Hi word)	-19999	99999	0	Read/Write	*Value shown here for reference
40032	Input B Offset Value (Lo word)					
40331	Max (Hi) Value Assignment	0	4	0	Read/Write	0=A-Rel, 1=A-Abs, 2=b-Rel, 3=bAbs, 4=Calc
40332	Max (Hi) Capture Delay Time	0	32750	10	Read/Write	0=Max Update Rate, 1=0.1 sec
40333	Min (Lo) Value Assignment	0	4	0	Read/Write	0=A-Rel, 1=A-Abs, 2=b-Rel, 3=bAbs, 4=Calc
40334	Min (Lo) Capture Delay Time	0	32750	10	Read/Write	0=Max Update Rate, 1=0.1 sec
40335	Display Update Time	0	4	0	Read/Write	0=1 Rdg/sec, 1=2 Rdgs/sec, 2=5 Rdgs/sec, 3=10 Rdgs/sec, 4=20 Rdgs/sec
40336	Units Annunciator Backlight	0	1	0	Read/Write	0=Off, 1=On
40337	Calculation Function	0	5	0	Read/Write	0 = C+A+B 1 = C-A-B 2 = C+A-B 3 = A*B/C 4 = C*A/B 5 = C(A/B-1) A=Input A, B=Input B, C=Calculation Constant
40338	Calculation Display Decimal Point	0	4	3	Read/Write	0=0, 1=0.0, 2=0.00, 3=0.000, 4=0.0000
40339	Calculation Constant Value High	-19999	99999	1000	Read/Write	
40340	Calculation Constant Value Low					
40341	Calculation Display Rounding Factor	0	6	0	Read/Write	0=1, 1=2, 2=5, 3=10, 4=20, 5=50, 6=100
40342	Calculation Display Filter Value	0	250	10	Read/Write	1=0.1 Second
40343	Calculation Filter Band	0	250	10	Read/Write	1=1 display unit
TOTALIZER PARAMETERS						
40351	Total Assignment	0	2	0	Read/Write	0=A-Rel, 1= b-Rel, 2= Calc
40352	Total Decimal Point	0	4	2	Read/Write	0=0, 1= 0.0, 2=0.00, 3=0.000, 4=0.0000
40353	Total Timebase	0	3	1	Read/Write	0=Second, 1=Minute, 2=Hour, 3=Day
40354	Total Scale Factor	0	65000	1000	Read/Write	1=0.001
40355	Total Low Cut Value (Hi word)	-19999	99999	-19999	Read/Write	
40356	Total Low Cut Value (Lo word)	-19999	99999	-19999	Read/Write	
40357	Total Reset at Power Up	0	1	0	Read/Write	0 = No, 1 = Yes
SETPOINT 1 OUTPUT PARAMETERS Note: SP Values are located at Registers 40013-40021						SEE MODULE 6 FOR DESCRIPTION OF PARAMETERS (APPLIES ONLY IF SP OPTION CARD, PAXCDS, IS INSTALLED)
40361	Assignment	0	6	0	Read/Write	0=None 1=A-Rel 2=A-Abs 3=b-Rel 4=b-Abs 5=Calc 6=Tot
40362	Action	0	10	0	Read/Write	0=No, 1=Ab-HI, 2=Ab-Lo, 3=AU-HI, 4=AU-LO, 9=totLo, 10=totHI; Do not use 5-8.
40363	Hysteresis	1	65000	2	Read/Write	1=1 Display Unit
40364	On Delay	0	32750	0	Read/Write	1=0.1 Second
40365	Off Delay	0	32750	0	Read/Write	1=0.1 Second
40366	Output Logic	0	1	0	Read/Write	0=Normal, 1=Reverse
40367	Reset	0	2	0	Read/Write	0=Auto, 1=Latch1, 2=Latch2
40368	Standby	0	1	0	Read/Write	0=No, 1 = Yes
40369	Lit - Annunciator	1	3	1	Read/Write	0=Off, 1=Normal, 2=Reverse, 3=Flash
SETPOINT 2 OUTPUT PARAMETERS						
40371	Assignment	0	6	0	Read/Write	0=None 1=A-Rel 2=A-Abs 3=b-Rel 4=b-Abs 5=Calc 6=Tot
40372	Action	0	10	0	Read/Write	0=No, 1=Ab-HI, 2=Ab-Lo, 3=AU-HI, 4=AU-LO, 5=dE-HI, 6=dE-LO, 7=bANd, 8=bNdn, 9=totLo, 10=totHI
40373	Hysteresis	1	65000	2	Read/Write	1=1 Display Unit
40374	On Delay	0	32750	0	Read/Write	1=0.1 Second
40375	Off Delay	0	32750	0	Read/Write	1=0.1 Second
40376	Output Logic	0	1	0	Read/Write	0=Normal, 1=Reverse
40377	Reset	0	2	0	Read/Write	0=Auto, 1=Latch1, 2=Latch2
40378	Standby	0	1	0	Read/Write	0=No, 1 = Yes
40379	Lit - Annunciator	0	3	1	Read/Write	0=Off, 1=Normal, 2=Reverse, 3=Flash

¹ For Input Registers, replace the 4xxxx with a 3xxxx in the above register address. The 3xxxx are a mirror of the 4xxxx Holding Registers.

² An attempt to exceed a limit will set the register to its high or low limit value.

REGISTER ADDRESS ¹	REGISTER NAME	LOW LIMIT ²	HIGH LIMIT ²	FACTORY SETTING	ACCESS	COMMENTS
SETPOINT 3 OUTPUT PARAMETERS						
40381	Assignment	0	6	0	Read/Write	0=None 1=A-Rel 2=A-Abs 3=b-Rel 4=bAbs 5=Calc 6=Tot
40382	Action	0	10	0	Read/Write	0=No, 1=Ab-HI, 2=Ab-Lo, 3=AU-HI, 4=AU-LO, 9=totLo, 10=totHI; Do not use 5-8.
40383	Hysteresis	1	65000	2	Read/Write	1=1 Display Unit
40384	On Delay	0	32750	0	Read/Write	1=0.1 Second
40385	Off Delay	0	32750	0	Read/Write	1=0.1 Second
40386	Output Logic	0	1	0	Read/Write	0=Normal, 1=Reverse
40387	Reset	0	2	0	Read/Write	0=Auto, 1=Latch1, 2=Latch2
40388	Standby	0	1	0	Read/Write	0=No, 1 = Yes
40389	Lit - Annunciator	0	3	1	Read/Write	0=Off, 1=Normal, 2=Reverse, 3=Flash
SETPOINT 4 OUTPUT PARAMETERS						
40391	Assignment	0	6	0	Read/Write	0=None 1=A-Rel 2=A-Abs 3=b-Rel 4=bAbs 5=Calc 6=Tot
40392	Action	0	10	0	Read/Write	0=No, 1=Ab-HI, 2=Ab-Lo, 3=AU-HI, 4=AU-LO, 5=dE-HI, 6=dE-LO, 7=bAND, 8=bNdl, 9=totLo, 10=totHI
40393	Hysteresis	1	65000	2	Read/Write	1=1 Display Unit
40394	On Delay	0	32750	0	Read/Write	1=0.1 Second
40395	Off Delay	0	32750	0	Read/Write	1=0.1 Second
40396	Output Logic	0	1	0	Read/Write	0=Normal, 1=Reverse
40397	Reset	0	2	0	Read/Write	0=Auto, 1=Latch1, 2=Latch2
40398	Standby	0	1	0	Read/Write	0=No, 1 = Yes
40399	Lit - Annunciator	0	3	1	Read/Write	0=Off, 1=Normal, 2=Reverse, 3=Flash
SERIAL COMMUNICATIONS PARAMETERS						SEE MODULE 7 FOR DESCRIPTION OF PARAMETERS
40401	Type	0	2	2	Read/Write	0=RLC Protocol, 1=Modbus RTU, 2=Modbus ASCII
40402	Baud Rate	0	7	7	Read/Write	0=300, 1=600, 2=1200, 3=2400, 4=4.8k, 5=9.6k, 6=19.2k, 7=38.4k
40403	Data Bits	0	1	1	Read/Write	0=7 bits, 1=8 bits
40404	Parity	0	2	0	Read/Write	0=None, 1=Even, 2=Odd
40405	Address	0	99	247	Read/Write	RLC Protocol: 0-99
		1	247			Modbus: 1-247
40406	Transmit Delay	0	250	10	Read/Write	1=0.001 Second
40407	Abbreviated Transmission (RLC only)	0	1		Read/Write	0=No, 1=Yes Not used when communications type is Modbus
40408	Print Options	0	63	0	Read/Write	0=No, 1=Yes Not used when communications type is Modbus Bit 0 - Print Input A Value Bit 1 - Print Input B Value Bit 2 - Print CALC Value Bit 3 - Print Max & Min Values Bit 4 - Print Total Value Bit 5 - Print Setpoint Values
40409	Load Serial Settings	0	1	0	Read/Write	Changing 40401-40406 will not update the PAXDP until this register is written with a 1. After the write, the communicating device must be changed to the new PAXDP settings and the register returns to 0.
ANALOG OUTPUT PARAMETERS						SEE MODULE 8 FOR DESCRIPTION OF PARAMETERS (APPLIES ONLY WHEN LINEAR OUTPUT CARD, PAXCDL IS INSTALLED)
40411	Type	0	2	1	Read/Write	0 = 0-20 mA, 1 = 4-20 mA, 2 = 0-10 V
40412	Assignment	0	8	0	Read/Write	0=NONE, 1=A-REL, 2=A-AbS, 3=b-rEL, 4=b-AbS, 5=CALC, 6=tot, 7=HI, 8=LO
40413	Analog Low Value (Hi word)	-19999	99999	0	Read/Write	Display value that corresponds with 0 V, 0 mA or 4 mA output
40414	Analog Low Value (Lo word)					
40415	Analog High Value (Hi word)	-19999	99999	10000	Read/Write	Display value that corresponds with 10 V or 20 mA output
40416	Analog High Value (Lo word)					
40417	Update Time	0	100	0	Read/Write	0=Max update rate, 1=0.1 second

¹ For Input Registers, replace the 4xxxx with a 3xxxx in the above register address. The 3xxxx are a mirror of the 4xxxx Holding Registers.

² An attempt to exceed a limit will set the register to its high or low limit value.

REGISTER ADDRESS ¹	REGISTER NAME	LOW LIMIT ²	HIGH LIMIT ²	FACTORY SETTING	ACCESS	COMMENTS
FACTORY SERVICE						
40501	Factory Service Register	N/A	N/A	N/A	Read/Write	Factory Use Only - Do Not Modify
40502	Factory Service Data Register	N/A	N/A	N/A	Read/Write	Factory Use Only - Do Not Modify
40503	Main Display Number	0	3	1	Read/Write	0=Display_, 1=Display A, 2=Display B, 3=Display C
40504	Power Up Errors	N/A	N/A	N/A	Read Only	Bit Cleared = No Error, Bit Set = Error Bit 0 = Input A Hardware Error (ErlnA) Bit 1 = Input B Hardware Error (ErlnB) Bit 2 = Key Stuck at power-up Error (ErKEY) Bit 3 = Power Down Data Checksum Error (EEPdn) Bit 4 = Parameter Checksum Error (EEPPar) Bit 5 = Calibration Data Checksum error (EECal) Bit 6 = Linear Output Card Calibration Checksum Data Error (EELin)
40505	Input A/B Error	N/A	N/A	N/A	Read Only	Bit Cleared = No Error, Bit Set = Error Bit 0 = Input A Display Underflow (<-19999) Bit 1 = Input A Display Overflow (>99999) Bit 2 = Input A Signal Underrange (<13 V or <-26 mA) Bit 3 = Input A Signal Overage (>13 V or >26 mA) Bit 4 = Input A Display Underflow (<-19999) Bit 5 = Input A Display Overflow (>99999) Bit 6 = Input A Signal Underrange (<13 V or <-26 mA) Bit 7 = Input A Signal Overage (>13 V or >26 mA)
40506	Total & Calculation Error	N/A	N/A	N/A	Read Only	Bit 0 = Calculation Display Underflow (<-19999) Bit 1 = Calculation Display Overflow (>99999) Bit 4 = Total Value Display Underflow (<-99999900) Bit 5 = Total Value Display Overflow (>999999000)
41001-41010	Slave ID	N/A	N/A	N/A	Read Only	RLC-PAXDP a b <0100h><20h><20h><10h> (a = "0", "2", "4" SP card installed; b = "0" or "1" Linear Card installed), 1.00 version (or higher)32 reads, 32 writes 16 scratch
41101-41116	GUID/Scratch	N/A	N/A	N/A	Read/Write	Reserved (may be used in future RLC software)

¹ For Input Registers, replace the 4xxx with a 3xxx in the above register address. The 3xxx are a mirror of the 4xxx Holding Registers.

² An attempt to exceed a limit will set the register to its high or low limit value.

SERIAL RLC PROTOCOL COMMUNICATIONS

RLC Communications requires the Serial Communications Type Parameter (**TYPE**) be set to **RLC**.

SENDING SERIAL COMMANDS AND DATA

When sending commands to the meter, a string containing at least one command character must be constructed. A command string consists of a command character, a value identifier, numerical data (if writing data to the meter) followed by a the command terminator character * or \$.

Command Chart

Command	Description	Notes
N	Node (Meter) Address Specifier	Address a specific meter. Must be followed by a one or two digit node address. Not required when address = 0.
T	Transmit Value (read)	Read a register from the meter. Must be followed by register ID character.
V	Value change (write)	Write to register of the meter. Must be followed by register ID character and numeric data.
R	Reset	Reset a register or output. Must be followed by register ID character
P	Block Print Request (read)	Initiates a block print output. Registers are defined in programming.

Command String Construction

The command string must be constructed in a specific sequence. The meter does not respond with an error message to invalid commands. The following procedure details construction of a command string:

1. The first characters consist of the Node Address Specifier (N) followed by a 1 or 2 character address number. The address number of the meter is programmable. If the node address is 0, this command and the node address itself may be omitted. This is the only command that may be used in conjunction with other commands.
2. After the address specifier, the next character is the command character.
3. The next character is the Register ID. This identifies the register that the command affects. The P command does not require a Register ID character. It prints according to the selections made in print options.
4. If constructing a value change command (writing data), the numeric data is sent next.
5. All command strings must be terminated with the string termination characters * or \$. The meter does not begin processing the command string until this character is received. See Timing Diagram figure for differences between terminating characters.

Register Identification Chart

ID	VALUE DESCRIPTION	REGISTER NAME ¹	COMMAND SUPPORTED ²
A	Input A Relative Value	INA	T, R (reset command zeros or tares input)
B	Input B Relative Value	INB	T, R (reset command zeros or tares input)
C	Calculation Value	CLC	T
D	Total	TOT	T, R (reset command zeros Total)
E	Min	MIN	T, R (reset command loads current reading)
F	Max	MAX	T, R (reset command loads current reading)
G	Input A Absolute (Gross) Value	ABA	T
H	Input B Absolute (Gross) Value	ABB	T
I	Input A Offset	OFA	T, V
J	Input B Offset	OFB	T, V
M	Setpoint 1	SP1	T, V, R (reset command resets setpoint output)
O	Setpoint 2	SP2	T, V, R (reset command resets setpoint output)
Q	Setpoint 3	SP3	T, V, R (reset command resets setpoint output)
S	Setpoint 4	SP4	T, V, R (reset command resets setpoint output)
U	Auto/Manual Register	MMR	T, V
W	Analog Output Register	AOR	T, V
X	Setpoint Register	SOR	T, V

1. Register Names are also used as Register Mnemonics during full transmission.
2. The registers associated with the P command are set up in Print Options (Module 7). Unless otherwise specified, the Transmit Details apply to both T and V Commands.

Command String Examples:

1. Address = 17, Write 350 to Setpoint 1
String: N17VM350*
2. Address = 5, Read Input A value
String: N5TA*
3. Address = 0, Reset Setpoint 4 output
String: RS*

Transmitting Data To the Meter

Numeric data sent to the meter must be limited to Transmit Details listed in the Register Identification Chart. Leading zeros are ignored. Negative numbers must have a minus sign. The meter ignores any decimal point and conforms the number to the scaled resolution. (ie. The meter's scaled decimal point position is set for 0.0 and 25 is written to a register. The value of the register is now 2.5. In this case, write a value of 250 to equal 25.0).

Note: Since the meter does not issue a reply to value change commands, follow with a transmit value command for readback verification.

Transmitting Data From the Meter

Data is transmitted from the meter in response to either a transmit command (T), a print block command (P) or User Function print request. The response from the meter is either a full field transmission or an abbreviated transmission. See Abbreviated Printing (**Rbrw**) parameter.

Full Transmission

Byte	Description
1, 2	2 byte Node (Meter) Address field [00-99]
3	<SP> (Space)
4-6	3 byte Register Mnemonic field
7-18	12 byte numeric data field: 10 bytes for number, one byte for sign, one byte for decimal point
19	<CR> (Carriage return)
20	<LF> (Line feed)
21	<SP> (Space) [☆]
22	<CR> (Carriage return) [☆]
23	<LF> (Line feed) [☆]

[☆] These characters only appear in the last line of a block print.

The first two characters transmitted (bytes 1 and 2) are the unit address. If the address assigned is 00, two spaces are substituted. A space (byte 3) follows the unit address field. The next three characters (bytes 4 to 6) are the register mnemonic. The numeric data is transmitted next.

The numeric field (bytes 7 to 18) is 12 characters long. When the requested value exceeds eight digits for count values or five digits for rate values. Byte 8 is always a space. The remaining ten positions of this field (bytes 9 to 18) consist of a minus sign (for negative values), a floating decimal point (if applicable), and eight positions for the requested value. The data within bytes 9 to 18 is right-aligned with leading spaces for any unfilled positions.

The end of the response string is terminated with <CR> (byte 19), and <LF> (byte 20). When a block print is finished, an extra <SP> (byte 21), <CR> (byte 22), and <LF> (byte 23) are used to provide separation between the transmissions.

Abbreviated Transmission

Byte	Description
1-12	12 byte data field, 10 bytes for number, one byte for sign, one byte for decimal point
13	<CR> (Carriage return)
14	<LF> (Line feed)
15	<SP> (Space) [☆]
16	<CR> (Carriage return) [☆]
17	<LF> (Line feed) [☆]

[☆] These characters only appear in the last line of a block print.

The abbreviated response suppresses the address and register mnemonics, leaving only the numeric part of the response.

Meter Response Examples:

1. Address = 17, full field response, Input A = 875
17 INA 875 <CR><LF>
2. Address = 0, full field response, Setpoint 2 = -250.5
SP2 -250.5<CR><LF>
3. Address = 0, abbreviated response, Setpoint 2 = 250, last line of block print
250<CR><LF><SP><CR><LF>

Auto/Manual Mode Register (MMR) ID: U

This register sets the controlling mode for the outputs. In Auto Mode (0) the meter controls the setpoint and analog output. In Manual Mode (1) the outputs are defined by the registers SOR and AOR. When transferring from auto mode to manual mode, the meter holds the last output value (until the register is changed by a write). Each output may be independently changed to auto or manual. In a write command string (VU), any character besides 0 or 1 in a field will not change the corresponding output mode.

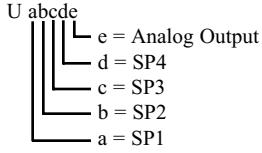

Example: VU00011 places SP4 and Analog in manual.

Analog Output Register (AOR) ID: W

This register stores the present signal value of the analog output. The range of values of this register is 0 to 4095, which corresponds to the analog output range per the following chart:

Register Value	Output Signal*		
	0-20 mA	4-20 mA	0-10V
0	0.000	4.000	0.000
1	0.005	4.004	0.0025
2047	10.000	12.000	5.000
4094	19.995	19.996	9.9975
4095	20.000	20.000	10.000

**Due to the absolute accuracy rating and resolution of the output card, the actual output signal may differ 0.15% FS from the table values. The output signal corresponds to the range selected (0-20 mA, 4-20 mA or 0-10 V).*

Writing to this register (VW) while the analog output is in the Manual Mode causes the output signal level to update immediately to the value sent. While in the Automatic Mode, this register may be written to, but it has no effect until the analog output is placed in the manual mode. When in the Automatic Mode, the meter controls the analog output signal level. Reading from this register (TW) will show the present value of the analog output signal.

Example: VW2047 will result in an output of 10.000 mA, 12.000 mA or 5.000V depending on the range selected.

Setpoint Output Register (SOR) ID: X

This register stores the states of the setpoint outputs. Reading from this register (TX) will show the present state of all the setpoint outputs. A “0” in the setpoint location means the output is off and a “1” means the output is on.

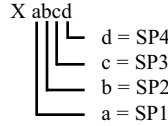

In Automatic Mode, the meter controls the setpoint output state. In Manual Mode, writing to this register (VX) will change the output state. Sending any character besides 0 or 1 in a field or if the corresponding output was not first in manual mode, the corresponding output value will not change. (It is not necessary to send least significant 0s.)

Example: VX10 will result in output 1 on and output 2 off.

COMMAND RESPONSE TIME

The meter can only receive data or transmit data at any one time (half-duplex operation). When sending commands and data to the meter, a delay must be imposed before sending another command. This allows enough time for the meter to process the command and prepare for the next command.

At the start of the time interval t1, the computer program prints or writes the string to the com port, thus initiating a transmission. During t1, the command characters are under transmission and at the end of this period, the command terminating character (*) is received by the meter. The time duration of t1 is dependent on the number of characters and baud rate of the channel.

$$t1 = (10 * \# \text{ of characters}) / \text{baud rate}$$

At the start of time interval t2, the meter starts the interpretation of the command and when complete, performs the command function. This time interval t2 varies from 2 msec to 15 msec. If no response from the meter is expected, the meter is ready to accept another command.

If the meter is to reply with data, the time interval t2 is controlled by the use of the command terminating character and the Serial Transmit Delay parameter (**dELAY**). The standard command line terminating character is '*'. This terminating character results in a response time window of the Serial Transmit Delay time (**dELAY**) plus 15msec. maximum. The **dELAY** parameter should be programmed to a value that allows sufficient time for the release of the sending driver on the RS485 bus. Terminating the command line with 'S' results in a response time window (t2) of 2 msec minimum and 15 msec maximum. The response time of this terminating character requires that sending drivers release within 2 msec after the terminating character is received.

At the beginning of time interval t3, the meter responds with the first character of the reply. As with t1, the time duration of t3 is dependent on the number of characters and baud rate of the channel.

$$t3 = (10 * \# \text{ of characters}) / \text{baud rate}$$

At the end of t3, the meter is ready to receive the next command. The maximum serial throughput of the meter is limited to the sum of the times t1, t2 and t3.

Timing Diagrams

NO REPLY FROM METER

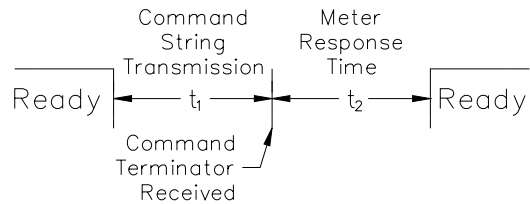

RESPONSE FROM METER

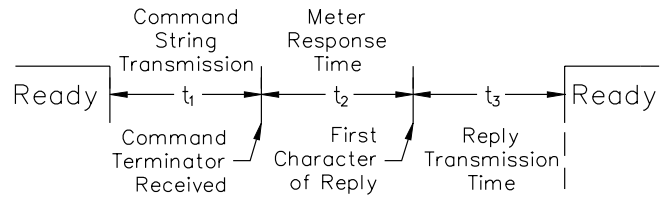

COMMUNICATION FORMAT

Data is transferred from the meter through a serial communication channel. In serial communications, the voltage is switched between a high and low level at a predetermined rate (baud rate) using ASCII encoding. The receiving device reads the voltage levels at the same intervals and then translates the switched levels back to a character.

The voltage level conventions depend on the interface standard. The table lists the voltage levels for each standard.

LOGIC	INTERFACE STATE	RS232*	RS485*
1	mark (idle)	TXD,RXD; -3 to -15 V	a-b < -200 mV
0	space (active)	TXD,RXD; +3 to +15 V	a-b > +200 mV

* Voltage levels at the Receiver

Data is transmitted one byte at a time with a variable idle period between characters (0 to ∞). Each ASCII character is “framed” with a beginning start bit, an optional parity bit and one or more ending stop bits. The data format and baud rate must match that of other equipment in order for communication to take place. The figures list the data formats employed by the meter.

Start bit and Data bits

Data transmission always begins with the start bit. The start bit signals the receiving device to prepare for reception of data. One bit period later, the least significant bit of the ASCII encoded character is transmitted, followed by the remaining data bits. The receiving device then reads each bit position as they are transmitted.

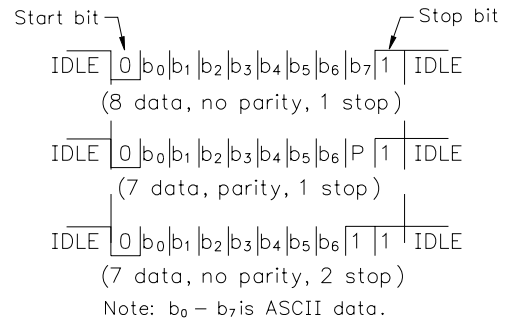

Character Frame Figure

Parity bit

After the data bits, the parity bit is sent. The transmitter sets the parity bit to a zero or a one, so that the total number of ones contained in the transmission (including the parity bit) is either even or odd. This bit is used by the receiver to detect errors that may occur to an odd number of bits in the transmission. However, a single parity bit cannot detect errors that may occur to an even number of bits. Given this limitation, the parity bit is often ignored by the receiving device. The PAX meter ignores the parity bit of incoming data and sets the parity bit to odd, even or none (mark parity) for outgoing data.

Stop bit

The last character transmitted is the stop bit. The stop bit provides a single bit period pause to allow the receiver to prepare to re-synchronize to the start of a new transmission (start bit of next byte). The receiver then continuously looks for the occurrence of the start bit. If 7 data bits and no parity is selected, then 2 stop bits are sent from the PAXDP.

5.8 MODULE 8 - ANALOG OUTPUT PARAMETERS (B-Out)

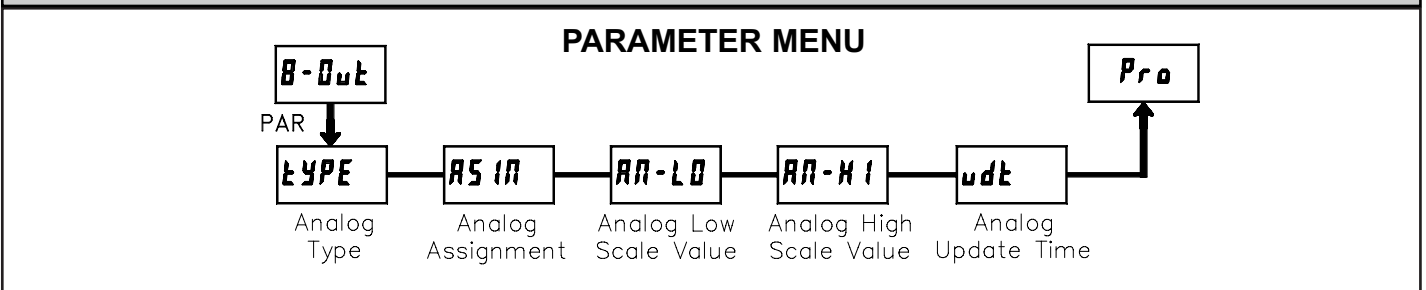

TYPE - ANALOG TYPE	0-20	0-10
	4-20	
RS IN - ANALOG ASSIGNMENT	none	A-rEL
	A-Rb5	b-rEL
	b-Rb5	CRLE
	LoL	HI
	LO	

AN-LO - ANALOG LOW SCALE VALUE	-19999 to 99999
AN-HI - ANALOG HIGH SCALE VALUE	-19999 to 99999
udt - ANALOG UPDATE TIME	00 to 100 sec.

5.9 MODULE 9 - FACTORY SERVICE OPERATIONS (9-FL5)

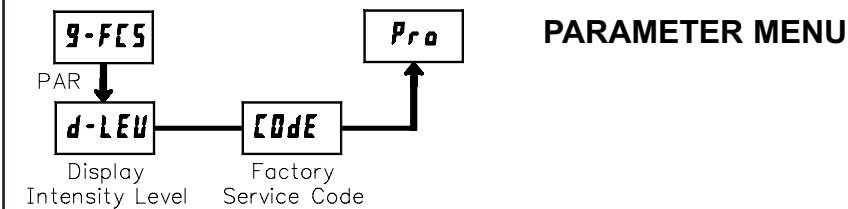

DISPLAY INTENSITY LEVEL

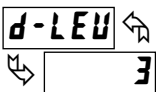

Enter the desired Display Intensity Level (0-15) by using the arrow keys. The display will actively dim or brighten as the levels are changed. This parameter also appears in Quick Programming Mode when enabled.

RESTORE FACTORY DEFAULTS

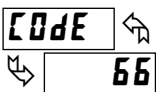

Use the arrow keys to display **CODE 66** and press **PAR**. The meter will display **RESET** and then return to **CODE 50**. Press **DSP** key to return to Display Mode. This will overwrite all user settings with the factory settings.

CALIBRATION

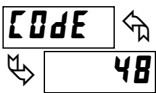

The meter has been fully calibrated at the factory. Scaling to convert the input signal to a desired display value is performed in Module 1. If the meter appears to be indicating incorrectly or inaccurately, refer to Troubleshooting before attempting to calibrate the meter.

When recalibration is required (generally every 2 years), it should only be performed by qualified technicians using appropriate equipment. Calibration does not change any user programmed parameters. However, it may affect the accuracy of the input signal values previously stored using the Apply (**APPLY**) Scaling Style.

Calibration may be aborted by disconnecting power to the meter before exiting Module 9. In this case, the existing calibration settings remain in effect.

INPUT CALIBRATION



WARNING: Calibration of this meter requires a signal source with an accuracy of 0.01% or better and an external meter with an accuracy of 0.005% or better.

Before starting, verify that the Input Ranger Jumper is set for the range to be calibrated. Also verify that the precision signal source is connected and ready. Allow a 30 minute warm-up period before calibrating the meter. **NO** and **PAR** can be chosen to exit the calibration mode without any changes taking place. Then perform the following procedure:

1. Use the arrow keys to display (**CODE 48**) and press **PAR**.
2. Choose the input channel/range to be calibrated by using the arrow keys and press **PAR**. (**NO** and **PAR** can be chosen to exit the calibration mode without any changes taking place.)
3. When the zero range limit appears on the display, apply the appropriate:
 - Voltage range: dead short applied
 - Current range: open circuit
4. Press **PAR** and the top range limit will appear on the display after approximately 1 second.
5. With the top range limit on the display, apply the appropriate:
 - Voltage range: 10 VDC
 - Current range: 20 mADC
6. Press **PAR** and **CAL**. **NO** will appear on the display after approximately 1 second.
7. When **NO** appears, press **PAR** twice.
8. If the meter is not field scaled, then the input display should match the value of the input signal.
9. Repeat the above procedure for each input range to be calibrated.

ANALOG OUTPUT CARD CALIBRATION

Before starting, verify that the precision voltmeter (voltage output) or current meter (current output) is connected and ready. Perform the following procedure:

1. Use the arrow keys to display **CODE 48** and press **PAR**.
2. Use the arrow keys to choose **OUT** and press **PAR**.
3. Using the chart below, step through the five selections to be calibrated. At each prompt, use the PAX arrow keys to adjust the external meter display to match the selection being calibrated. When the external reading matches, or if this range is not being calibrated, press **PAR**.

SELECTION	EXTERNAL METER	ACTION
00.A	0.00	Adjust if necessary, press PAR
40.A	4.00	Adjust if necessary, press PAR
200.A	20.00	Adjust if necessary, press PAR
00.u	0.00	Adjust if necessary, press PAR
100.u	10.00	Adjust if necessary, press PAR

4. When **NO** appears remove the external meters and press **PAR** twice.

This page intentionally left blank

TROUBLESHOOTING

PROBLEM	REMEDIES
NO DISPLAY	CHECK: Power level, power connections, Module 3 programming
PROGRAM LOCKED-OUT	CHECK: Active (lock-out) user input ENTER: Security code requested
DISPLAY LOCKED-OUT	CHECK: Module 3 programming
INCORRECT INPUT DISPLAY VALUE	CHECK: Module 1 programming, Input Jumper position, input connections, input signal level, Module 4 Display Offset is zero, press DSP for Input Display PERFORM: Module 9 Calibration (If the above does not correct the problem.)
"OOL" in DISPLAY (SIGNAL HIGH)	CHECK: Module 1 programming, Input Range Jumper position, input connections, input signal level
"ULUL" in DISPLAY (SIGNAL LOW)	CHECK: Module 1 programming, Input Range Jumper position, input connections, input signal level
JITTERY DISPLAY	INCREASE: Module 1 filtering, rounding, input range CHECK: Wiring is per EMC installation guidelines
MODULES or PARAMETERS NOT ACCESSIBLE	CHECK: Corresponding plug-in card installation
ERROR CODE (Err xxx or EE xxx)	PRESS: Reset KEY (If cannot clear contact factory.)

For further assistance, contact technical support at the appropriate company numbers listed.

PARAMETER VALUE CHART Programmer _____ Date _____
PAXDP MODEL NUMBER _____ Meter# _____ Security Code _____

1- INP Signal Input Parameters

DISPLAY	PARAMETER	FACTORY SETTING	INPUT A USER SETTING	INPUT B USER SETTING	DISPLAY	PARAMETER	FACTORY SETTING	INPUT A USER SETTING	INPUT B USER SETTING
<i>rRNGE</i>	INPUT RANGE	<i>uolt</i>	_____	_____	<i>INP 7</i>	INPUT VALUE 7	<i>0.000</i>	_____	_____
<i>rRtE</i>	UPDATE RANGE	<i>198</i>	_____	_____	<i>dSP 7</i>	DISPLAY VALUE 7	<i>0.000</i>	_____	_____
<i>dECPt</i>	DISPLAY RESOLUTION	<i>0.000</i>	_____	_____	<i>INP 8</i>	INPUT VALUE 8	<i>0.000</i>	_____	_____
	DISPLAY ROUNDING INCREMENT	<i>0.001</i>	_____	_____	<i>dSP 8</i>	DISPLAY VALUE 8	<i>0.000</i>	_____	_____
<i>round</i>			_____	_____	<i>INP 9</i>	INPUT VALUE 9	<i>0.000</i>	_____	_____
<i>F ltr</i>	FILTER SETTING	<i>10</i>	_____	_____	<i>dSP 9</i>	DISPLAY VALUE 9	<i>0.000</i>	_____	_____
<i>bRRd</i>	FILTER ENABLE BAND	<i>00 10</i>	_____	_____	<i>INP 10</i>	INPUT VALUE 10	<i>0.000</i>	_____	_____
<i>PtS</i>	SCALING POINTS	<i>2</i>	_____	_____	<i>dSP 10</i>	DISPLAY VALUE 10	<i>0.000</i>	_____	_____
<i>StYLE</i>	SCALING STYLE	<i>KEY</i>	_____	_____	<i>INP 11</i>	INPUT VALUE 11	<i>0.000</i>	_____	_____
<i>INP 1</i>	INPUT VALUE 1	<i>0.000</i>	_____	_____	<i>dSP 11</i>	DISPLAY VALUE 11	<i>0.000</i>	_____	_____
<i>dSP 1</i>	DISPLAY VALUE 1	<i>0.000</i>	_____	_____	<i>INP 12</i>	INPUT VALUE 12	<i>0.000</i>	_____	_____
<i>INP 2</i>	INPUT VALUE 2	<i>10.000</i>	_____	_____	<i>dSP 12</i>	DISPLAY VALUE 12	<i>0.000</i>	_____	_____
<i>dSP 2</i>	DISPLAY VALUE 2	<i>10.000</i>	_____	_____	<i>INP 13</i>	INPUT VALUE 13	<i>0.000</i>	_____	_____
<i>INP 3</i>	INPUT VALUE 3	<i>0.000</i>	_____	_____	<i>dSP 13</i>	DISPLAY VALUE 13	<i>0.000</i>	_____	_____
<i>dSP 3</i>	DISPLAY VALUE 3	<i>0.000</i>	_____	_____	<i>INP 14</i>	INPUT VALUE 14	<i>0.000</i>	_____	_____
<i>INP 4</i>	INPUT VALUE 4	<i>0.000</i>	_____	_____	<i>dSP 14</i>	DISPLAY VALUE 14	<i>0.000</i>	_____	_____
<i>dSP 4</i>	DISPLAY VALUE 4	<i>0.000</i>	_____	_____	<i>INP 15</i>	INPUT VALUE 15	<i>0.000</i>	_____	_____
<i>INP 5</i>	INPUT VALUE 5	<i>0.000</i>	_____	_____	<i>dSP 15</i>	DISPLAY VALUE 15	<i>0.000</i>	_____	_____
<i>dSP 5</i>	DISPLAY VALUE 5	<i>0.000</i>	_____	_____	<i>INP 16</i>	INPUT VALUE 16	<i>0.000</i>	_____	_____
<i>INP 6</i>	INPUT VALUE 6	<i>0.000</i>	_____	_____	<i>dSP 16</i>	DISPLAY VALUE 16	<i>0.000</i>	_____	_____
<i>dSP 6</i>	DISPLAY VALUE 6	<i>0.000</i>	_____	_____				_____	_____

2-FNC User Input and Function Key Parameters

DISPLAY	PARAMETER	FACTORY SETTING	USER SETTING
USr-1	USER INPUT 1	NO	_____
USr-2	USER INPUT 2	NO	_____
F1	FUNCTION KEY 1	NO	_____
F2	FUNCTION KEY 2	NO	_____
rSt	RESET KEY	NO	_____
Sc-F1	2nd FUNCTION KEY 1	NO	_____
Sc-F2	2nd FUNCTION KEY 2	NO	_____

3-LDC Display and Program Lockout Parameters

DISPLAY	PARAMETER	FACTORY SETTING	USER SETTING
INP A	INPUT A ASSIGNMENT	dSP-A	_____
INP b	INPUT B ASSIGNMENT	dSP-b	_____
CALC	CALCULATION ASSIGNMENT	dSP-C	_____
HI	MAX DISPLAY LOCKOUT	LDC	_____
LO	MIN DISPLAY LOCKOUT	LDC	_____
	TOTAL DISPLAY LOCKOUT	LDC	_____
SP-1	SETPOINT 1 ACCESS	LDC	_____
SP-2	SETPOINT 2 ACCESS	LDC	_____
SP-3	SETPOINT 3 ACCESS	LDC	_____
SP-4	SETPOINT 4 ACCESS	LDC	_____
CODE	SECURITY CODE	0	_____

4-SEC Secondary Function Parameters

DISPLAY	PARAMETER	FACTORY SETTING	USER SETTING
OFFS-A	INPUT A OFFSET VALUE	0000	_____
OFFS-b	INPUT B OFFSET VALUE	0000	_____
HI-AS	MAX CAPTURE ASSIGNMENT	R-rEL	_____
HI-t	MAX CAPTURE DELAY TIME	10	_____
LO-AS	MIN CAPTURE ASSIGNMENT	R-rEL	_____
LO-t	MIN CAPTURE DELAY TIME	10	_____
dSP-t	DISPLAY UPDATE TIME	1	_____
b-L It	UNITS LABEL BACKLIGHT	OFF	_____
Func	CALCULATION FUNCTION	c 1R 1b	_____
dP	CALCULATION DECIMAL POINT	0000	_____
const	CALCULATION CONSTANT VALUE	1000	_____
rnd	CALCULATION ROUNDING	000 1	_____
FLt	CALCULATION FILTER SETTING	10	_____
bnf	CALCULATION FILTER BAND	00 10	_____

5-SPt Setpoint (Alarm) Parameters

DISPLAY	PARAMETER	SP-1		SP-2		SP-3		SP-4	
		FACTORY SETTING	USER SETTING	FACTORY SETTING	USER SETTING	FACTORY SETTING	USER SETTING	FACTORY SETTING	USER SETTING
SPSEL	SELECT SETPOINT	NO	_____	NO	_____	NO	_____	NO	_____
ASN-n	SETPOINT ASSIGNMENT	NONE	_____	NONE	_____	NONE	_____	NONE	_____
ACT-n	SETPOINT ACTION	NO	_____	NO	_____	NO	_____	NO	_____
SP-n	SETPOINT VALUE (main)	100	_____	200	_____	300	_____	400	_____
	SETPOINT VALUE (alternate) *	100	_____	200	_____	300	_____	400	_____
HYS-n	SETPOINT HYSTERESIS	2	_____	2	_____	2	_____	2	_____
TON-n	ON TIME DELAY	00	_____	00	_____	00	_____	00	_____
TOF-n	OFF TIME DELAY	00	_____	00	_____	00	_____	00	_____
OUT-n	OUTPUT LOGIC	nor	_____	nor	_____	nor	_____	nor	_____
rSt-n	RESET ACTION	RUto	_____	RUto	_____	RUto	_____	RUto	_____
Stb-n	STANDBY OPERATION	NO	_____	NO	_____	NO	_____	NO	_____
LIt-n	SETPOINT ANNUNCIATORS	nor	_____	nor	_____	nor	_____	nor	_____

*Select alternate list to program these values.

5-tDt Totalizer (Integrator) Parameters

DISPLAY	PARAMETER	FACTORY SETTING	USER SETTING
AS IN	TOTALIZER ASSIGNMENT	R-rEL	_____
DECPt	TOTALIZER DECIMAL POINT	0000	_____
tBASE	TOTALIZER TIME BASE	17 in	_____
SCFAC	TOTALIZER SCALE FACTOR	1000	_____
LOCut	TOTALIZER LOW CUT VALUE	-19999	_____
P-uP	TOTALIZER POWER-UP RESET	NO	_____

7-5rL Serial Communication Parameters

DISPLAY	PARAMETER	FACTORY SETTING	USER SETTING
tYPE	COMMUNICATIONS TYPE	17bRS	_____
bAUD	BAUD RATE	38400	_____
dARt	DATA BIT	8	_____
PAR	PARITY BIT	NO	_____
Raddr	METER ADDRESS	247	_____
dELAY	TRANSMIT DELAY	00 10	_____
Rbr u	ABBREVIATED PRINTING	NO	_____
OPt	PRINT OPTIONS	NO	_____
INP A	INPUT A VALUE	NO	_____
INP b	INPUT B VALUE	NO	_____
CALC	CALCULATION	NO	_____
tot	PRINT TOTAL VALUE	NO	_____
HILO	PRINT MAX & MIN VALUES	NO	_____
SPnt	PRINT SETPOINT VALUES	NO	_____

Shaded area available when communications type is rLL.

8-OUT Analog Output Parameters

DISPLAY	PARAMETER	FACTORY SETTING	USER SETTING
tYPE	ANALOG TYPE	4-20	_____
AS IN	ANALOG ASSIGNMENT	0	_____
AN-LO	ANALOG LOW SCALE VALUE	0	_____
AN-HI	ANALOG HIGH SCALE VALUE	10000	_____
udt	ANALOG UPDATE TIME	00	_____

9-FCS Factory Setting Parameters

DISPLAY	PARAMETER	FACTORY SETTING	USER SETTING
d-LEV	DISPLAY INTENSITY LEVEL	3	_____

PAXDP PROGRAMMING QUICK OVERVIEW

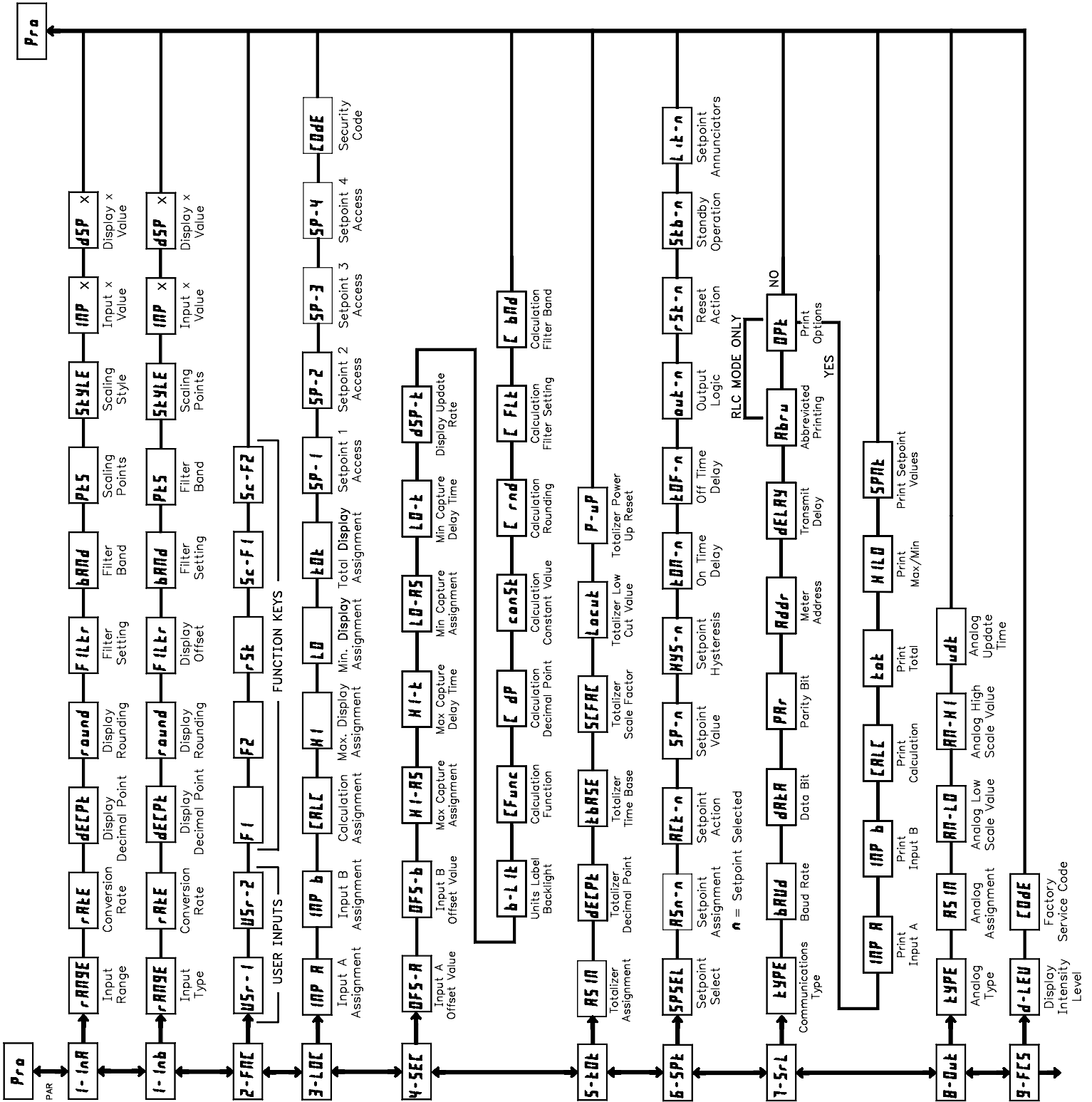

This page intentionally left blank

LIMITED WARRANTY

The Company warrants the products it manufactures against defects in materials and workmanship for a period limited to one year from the date of shipment, provided the products have been stored, handled, installed, and used under proper conditions. The Company's liability under this limited warranty shall extend only to the repair or replacement of a defective product, at The Company's option. The Company disclaims all liability for any affirmation, promise or representation with respect to the products.

The customer agrees to hold Red Lion Controls harmless from, defend, and indemnify RLC against damages, claims, and expenses arising out of subsequent sales of RLC products or products containing components manufactured by RLC and based upon personal injuries, deaths, property damage, lost profits, and other matters which Buyer, its employees, or sub-contractors are or may be to any extent liable, including without limitation penalties imposed by the Consumer Product Safety Act (P.L. 92-573) and liability imposed upon any person pursuant to the Magnuson-Moss Warranty Act (P.L. 93-637), as now in effect or as amended hereafter.

No warranties expressed or implied are created with respect to The Company's products except those expressly contained herein. The Customer acknowledges the disclaimers and limitations contained herein and relies on no other warranties or affirmations.

Red Lion Controls
20 Willow Springs Circle
York PA 17402
Tel +1 (717) 767-6511
Fax +1 (717) 764-0839

Red Lion Controls BV
Basicweg 11b
NL - 3821 BR Amersfoort
Tel +31 (0) 334 723 225
Fax +31 (0) 334 893 793

Red Lion Controls AP
31, Kaki Bukit Road 3,
#06-04/05 TechLink
Singapore 417818
Tel +65 6744-6613
Fax +65 6743-3360